

rotork[®]

Keeping the World Flowing
for Future Generations

CMA Range

Installation & Maintenance Instructions
(After May 2014)



Linear, Rotary and Quarter-Turn Control Valve Actuators

Contents

Section	Page	Section	Page
1. Introduction	3	9.5 Set Output Torque/Thrust	29
2. General Information	4	9.6 Select Action at End of Travel	31
2.1 Introduction	4	9.7 Set Closed Limit of Travel	33
2.2 Enclosure Materials	4	9.8 Set Open Limit of Travel	34
2.3 General Actuator Description	5	9.9 Calibrate Command Signal Zero Setpoint	35
2.4 Receiving / Inspection	6	9.10 Set Command Signal Invert	38
2.5 Storage	6	9.11 Set Transmitter Signal Invert	39
2.6 Equipment Return	6	9.12 Set Deadband	40
2.7 Abbreviations used in this Manual	6	9.13 Completing Basic Setup	41
2.8 Warranty Information	6	10. Menu Structure	43
2.9 Identification Label	6	10.1 Menu Structure	43
3. Health & Safety	7	11. Status Alarm Menu	44
4. Installation & Setup	8	11.1 Status Indication	44
4.1 Commissioning	8	12. Fault History Menu	46
4.2 Installing your Actuator	9	12.1 Fault History	46
5. Mounting the Actuator – CML Linear Actuators Only	13	13. Default Menu	48
5.1 CML - Linear Unit - Mounting	13	13.1 Default Menus	48
6. Mounting the Actuator – CMQ Quarter-Turn Actuators Only	16	13.2 Parameter Default Values	49
6.1 CMQ - Quarter-Turn Unit - Mounting	16	14. Advanced Menu	51
7. Mounting the Actuator – CMR Rotary Actuators Only	19	14.1 Advanced Menu Access	51
7.1 CMR - Rotary (Multi-Turn) Unit Mounting (Non-Thrust)	19	14.2 Advanced Menu	52
8. Installation & Setup – All CMA Units	21	15. Power Ratings	60
8.1 Electrical Installation	21	16. Rotork Sales and Service	60
9. Basic Setup	24	Appendix A: Approvals	61
9.1 Basic Setup	24	Non-Hazardous Area Enclosures	61
9.2 Basic Menu Structure	25	Hazardous Area Enclosures	61
9.3 Basic Setup Flowchart	26	Environmental Conditions	62
9.4 Select Local Operation	27	Special Conditions For Safe Use (ATEX, IECEx, UKCA and CSA approved actuators)	63
		Certification Numbers	63



THIS MANUAL CONTAINS IMPORTANT SAFETY INFORMATION. PLEASE ENSURE IT IS THOROUGHLY READ AND UNDERSTOOD BEFORE INSTALLING, OPERATING OR MAINTAINING THE EQUIPMENT.

DUE TO WIDE VARIATIONS IN THE TERMINAL NUMBERING OF ACTUATOR PRODUCTS, ACTUAL WIRING OF THIS DEVICE SHOULD FOLLOW THE PRINT SUPPLIED WITH THE UNIT.

1. Introduction

Rotork designs, manufactures, and tests its products to meet many national and international standards. For these products to operate within their normal specifications, they must be properly installed and maintained.

The following instructions must be followed and integrated with your safety program when installing and using Rotork products:

- Read and save all instructions prior to installing, operating and servicing this product
- If you don't understand any of the instructions, contact Rotork for clarification
- Follow all warnings, cautions and instructions marked on, and supplied with, the product
- Inform and educate personnel in the proper installation, operation and maintenance of the product
- Install equipment as specified in Rotork installation instructions and per applicable local and national codes. Connect all products to the proper electrical sources
- To ensure proper performance, use qualified personnel to install, operate, update and maintain the unit
- When replacement parts are required, ensure that the qualified service technician uses replacement parts specified by Rotork. Substitutions may result in fire, electrical shock, other hazards, or improper equipment operation
- Keep all product protective covers in place (except when installing, or when maintenance is being performed by qualified personnel), to prevent electrical shock, personal injury or actuator damage
- Operation of actuator in an inappropriate fashion may cause harm or damage to unit or other equipment surroundings



Linear CML



Quarter-Turn CMQ



Rotary CMR

2. General Information

2.1 Introduction

This manual has been produced to enable a competent user to install, operate, adjust and inspect the Rotork range of compact control valve actuators.

The electrical installation, maintenance and use of these actuators should be carried out in accordance with the National Legislation and Statutory Provisions relating to the safe use of this equipment applicable to the site of installation.

For the UK: Electricity at Work Regulations 1989 and the guidance given in the applicable edition of the 'IEE Wiring Regulations' should be applied. Also the user should be fully aware of their duties under the Health and Safety at Work Act 1974.

For the USA: NFPA70, National Electrical Code® is applicable. The mechanical installation should be carried out as outlined in this manual and also in accordance with any relevant national standard codes of practice. If the actuator nameplate indicates that it is suitable for use in a Potentially Explosive Atmospheres (Hazardous Areas) then the actuator is suitable for use in Zone 1 and Zone 2 (or Div 1 and Div 2) hazardous area classifications, as defined by the actuator's nameplate marking.

Any equipment connected to the actuator should be of an equivalent (or better) hazardous area certification. The installation, maintenance and use of the actuator installed in a hazardous area must be carried out by a competent person and in accordance with all relevant codes of practice for the particular Hazardous Area certification.

Any inspection or repair of Hazardous Area approved actuators should not be undertaken unless it conforms to National Legislation and Statutory Provisions relating to the specific Hazardous Area.

Only Rotork approved actuator replacement parts should be used. Under no circumstances should any modification or alteration be carried out on the actuator, as this could invalidate the conditions under which its certification was granted.

Access to live electrical conductors is forbidden in a Hazardous Area unless it is done under a special permit to work, otherwise all power should be isolated and the actuator moved to a non-hazardous area for repair or attention.

Only persons competent by virtue of their training or experience should be allowed to install, maintain and repair Rotork actuators. Work undertaken must be carried out in accordance with instructions in the manual. The user and those persons working on this equipment should be familiar with their responsibilities under any statutory provisions relating to the Health and Safety of their workplace.

2.2 Enclosure Materials

The enclosures on the Rotork range of control valve actuators are manufactured from aluminium alloy with stainless steel fasteners.

The user must ensure that the operating environment and any materials surrounding the actuator cannot lead to a reduction in the safe use of, or the protection afforded by, the actuator. Where appropriate the user must ensure the actuator is suitably protected against its operating environment.

Should further information and guidance relating to the safe use of the Rotork control valve actuator range be required, it will be provided on request.

2. General Information

2.3 General Actuator Description

Building on Rotork's historical success with innovative technology, the CMA offers a highly accurate and responsive method of automating control valves and pumps without the complexity and cost of a pneumatic supply.

With a minimum resolution of 0.2% of full stroke for linear & quarter-turn units and 2° of full stroke for multi-turn, the Rotork CMA range helps to maximize product quality and plant capacity.

CMA range actuators are self contained, purpose designed and built for continuous remote electrical operation of control valves.

CMA range of actuators delivers a series of sizes suitable for almost all linear, quarter-turn and rotary control valve and pump applications requiring exact position control and continuous modulation.

Refer to Appendix A – Approvals for further detail concerning approved actuators.

2.3.1 CML - Linear

The CML is a high precision linear actuator. It is capable of producing between 100 to 750 pounds of force and a maximum of 2 inch stroke length at a speed of between 0.125 to 0.25 inches per second.

NOTE: Thrust and Speed are dependant on frame size.

See PUB094-001 for full details.

2.3.2 CMQ - Quarter-Turn Actuators

The CMQ is a high precision quarter-turn actuator capable of producing between 250 to 1000 lbf.in at speeds between 5 to 22 seconds for a 90° operation.

NOTE: Torque and operating times are dependant on frame size.

See PUB094-001 for full details.

2.3.3 CMR - Rotary

The CMR is a high precision rotary unit with torque outputs between 50 to 250 inch pounds at output speeds between 5 to 24 RPM depending on frame size.

NOTE: Torque and operating times are dependant on frame size.

The actuator comprises:

- Absolute encoder
- LCD user interface
- DC brushless electric motor
- Simple, maintenance free geartrain
- Motor controller with travel and torque/thrust adjustment
- Manual override
- Hazardous area certification meeting international and national requirements
- Options
 - Local controls & external display
 - Reserve Power Pack (RPP)
 - Bus system option PCB
 - Remote Input Relay Output
RIRO option PCB card

2. General Information

2.4 Receiving / Inspection

Carefully inspect for shipping damage. Damage to the shipping carton is usually a good indication that it has received rough handling. Report all damage immediately to the freight carrier and Rotork Controls Ltd.

Unpack the product and information packet taking care to save the shipping carton and any packing material should return be necessary. Verify that the items on the packing list or bill of lading agree with your own documentation.

Rotork cannot accept responsibility for deterioration caused on-site once the covers are removed. Every Rotork actuator has been fully tested before leaving the factory to give years of trouble free operation providing it is correctly commissioned, installed and sealed.

WARNING

Before installing the actuator, make sure that it is suitable for the intended application. If you are unsure of the suitability of this equipment for your installation consult Rotork prior to installation.

WARNING: ELECTRIC SHOCK HAZARD

Installation and servicing must be performed only by qualified personnel.

WARNING: ELECTROSTATIC DISCHARGE

This equipment houses static sensitive devices. To protect the internal components never touch the printed circuit boards without using electrostatic control procedures.

WARNING

Protection provided by the equipment may be impaired if used in a manner not specified by Rotork.

2.5 Storage

If your actuator cannot be installed immediately store it in a dry place until you are ready to connect incoming cables.

If the actuator has to be installed but cannot be cabled it is recommended that any plastic cable entry plugs are replaced with PTFE sealed metal plugs.

2.6 Equipment Return

If your Rotork actuator has been correctly installed and sealed it will give years of trouble free service.

Should you require technical assistance or spares, Rotork guarantees the best service in the world. Contact your local Rotork representative or the factory direct at the address on the nameplate, quoting the actuator type and serial number.

2.7 Abbreviations used in this Manual

A	Ampere	NEMA	National Electrical Manufacturing Association
AC	Alternating Current	Nm	Newton Meter
°C	Degrees Celsius	NPT	National Pipe Thread
CW	Clockwise	PCB	Printed Circuit Board
ACW	Anti-clockwise	PL	Position Limit switch
CCW	Counter-clockwise	RPM	Revolutions per Minute
DC	Direct Current	SEC	Second
°F	Degrees Fahrenheit	V	Volts
G	Earth Ground	VA	Volt Amps
Hz	Hertz	VAC	Volts AC
kg	Kilogram	VDC	Volts DC
L	Line (power supply)	VR	Variable Resistance
lbf	Pounds Force	W	Watt
lbf.in	Inch Pounds		Direct current
lbf.ft	Foot Pounds		Protective Conductor Terminal
mA	Milliamp		Caution
mfd	Microfarad		
mm	Millimeters		
N	Newton (force)		

2.8 Warranty Information

Warranty: Subject to the following, Rotork expressly warrants the products manufactured by it as meeting the applicable Rotork product specifications and that such products are free from defects in material and workmanship for a period of one (1) year from the date of delivery. The foregoing is the sole and exclusive warranty made by Rotork with respect to the products. Rotork makes no other warranties, either express or implied (including, without limitation, warranties as to merchantability or fitness for a particular purpose). The purchaser retains responsibility for the application and functional adequacy of the offering. See Rotork's General Conditions of Sale - Product, for complete warranty information.

2.9 Identification Label

An identification label is attached to each actuator. When ordering parts, requesting information or service assistance, please provide all of the label information. **You must supply the serial number with all enquiries.**

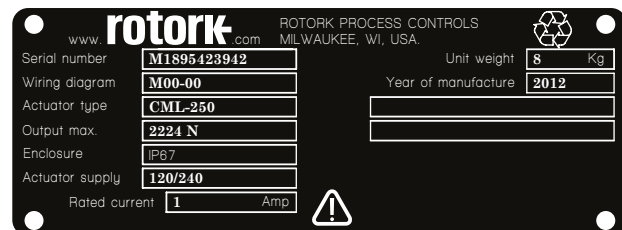

Fig 2.1 Actuator identification label

3. Health & Safety

WARNING

Before installing the actuator, make sure that it is suitable for the intended application. If you are unsure of the suitability of this equipment for your installation consult Rotork prior to installation.

WARNING

Protection provided by the equipment may be impaired if used in a manner not specified by Rotork.

WARNING: ELECTRIC SHOCK HAZARD

Installation and servicing must be performed only by qualified personnel.

WARNING: ELECTROSTATIC DISCHARGE

This equipment houses static sensitive devices. To protect the internal components never touch the printed circuit boards without using electrostatic (ESD) control procedures.

WARNING: ENCLOSURE MATERIALS

CMA actuator castings are manufactured from aluminium alloy with stainless steel fasteners. The user must ensure that the operating environment and any materials surrounding the actuator cannot lead to a reduction in the safe use of, or the protection afforded by the actuator.

Where appropriate the user must ensure the actuator is suitably protected against its operating environment.

WARNING: OPERATING BY HAND

Note that under no circumstances should any additional lever device such as a wheel key or wrench be applied to the hand-wheel in order to develop more force when closing or opening the valve. This may cause damage to the valve and/or actuator and it may also cause the valve to become stuck in the seated or back seated position.

WARNING: ACTUATORS WITH LOCAL CONTROLS

Note selection of the 'STOP' position on the Local/ Stop/Remote control knob does not guarantee that the actuator will lock in place.

ESD and the RPP power failure actions can be configured to take priority and actuator movement may occur.

WARNING

The screws securing the outer window frame maintain the integrity of the flame proof enclosure and must NOT be removed.

WARNING

Do not remove the top cover assembly or conduit entry blanking plugs when an explosive environment is present.

WARNING: RESERVE POWER PACK

Where actuators are supplied with the Reserve Power Pack assembly please note that the actuator output shaft may move after removal of the power supply.

WARNING

For actuators fitted with failsafe Reserve Power Pack only.

The Reserve Power Pack assembly mounted inside the top cover assembly contains super capacitor cells. Do not attempt to remove actuator to valve fixings or the top cover assembly whilst the actuator external local display is illuminated and/or flashing.

The super capacitors may take up to 30 minutes to discharge after removal of the power supply and the LED indicator remains illuminated during this time.

Super capacitors contain toxic/irritant materials. If the top cover assembly has to be removed for any reason ensure that the super capacitors are fully discharged and the area is adequately ventilated prior to removal of the top cover assembly, allow any vapours to disperse before gaining entry in to the enclosure.

Use appropriate hand/eye protection and inspect the super capacitor cells for signs of liquid or gel leakage before handling.

When working with capacitors ensure adequate ventilation, protect hands and eyes from contact by use of Butyl or Neoprene gloves and safety goggles. Wash hands after handling damaged cells.

Dispose of failsafe Reserve Power Pack module in accordance with federal, state and local regulations.

A material data sheet is available from Rotork upon request.

Ensure all LED's on the UPS assembly are extinguished before removal of the Power pack assembly from the top cover. If the LED's are illuminated or flashing DO NOT remove the power pack assembly from the top cover.

WARNING

The equipment utilizes a non-metallic outer coating and has a potential static hazard. Clean only with a damp cloth.

4. Installation & Setup

4.1 Commissioning

The Rotork CMA Range of actuators provide simple, safe and rapid commissioning.

Tools & Equipment Required (General Guideline Only)

Top Cover Fixings	-	6 mm Allen Wrench
Electrical Connections	-	Terminal Screw Driver
Command & Feedback	-	4 to 20 mA Command source/meter
Actuator to Valve fixings	-	As required

CAUTION

It is essential that the setup procedure is carried out when the valve is not under working process conditions, as full valve movement may occur.

IMPORTANT

It is essential that the actuator is mounted correctly to the valve!

WARNING

Where actuators are fitted with Reserve Powerpack assembly please note that the actuator output shaft may move after removal of the power supply.

After disconnection of the power supply wait until the flashing Red/White External LCD display has extinguished before removal of the top cover assembly to gain access to the electrical compartment of the actuator!

WARNING

Under NO circumstances attempt to move the actuator or adjust the output drive shaft connection to the valve stem whilst the External Local display is illuminated.

DO NOT REMOVE THE TOP COVER ASSEMBLY TO GAIN ACCESS TO THE ELECTRICAL COMPARTMENT WHILST THE LOCAL DISPLAY IS ILLUMINATED.

WAIT UNTIL THE DISPLAY IS EXTINGUISHED, THIS COULD TAKE UP TO 30 MINUTES AFTER POWER DOWN.

The height of the yoke or pillar and mounting plate, in relation to the top of the valve spindle is critical to ensure full stroke movement of the valve.

The Installation & Setup will include the following steps:

1. Ensure valve position is noted and safe (offline)
2. Actuator output shaft is retracted (linear units only)
3. Actuator is in closed position (rotary units only)
4. Mount and align actuator to valve
5. Set limits of travel
6. Configure control and indication parameters

4. Installation & Setup

4.2 Installing your Actuator

The following instructions must be followed and integrated into your safety program when installing and using Rotork products.

- Read and save all instructions prior to installing, operating and servicing this product
- If you don't understand any of the instructions contact Rotork for clarification
- Follow all warnings, cautions and instructions marked on and supplied with the product
- Inform and educate personnel in the proper installation, operation and maintenance of the product
- Protection provided by the equipment may be impaired if used in a manner not specified by Rotork

Install equipment as specified in Rotork installation instructions and as per applicable local and national codes of practice. Connect all products to the proper electrical sources.

- To ensure proper performance, use only qualified personnel to install, operate, update and maintain the unit
- When replacement parts are required, ensure that the qualified service technician uses only replacement parts specified by Rotork
- Substitutions will invalidate any hazardous area certification and may result in fire, electrical shock, other hazards or improper operation
- Keep all product protective covers in place (except during installation or maintenance by qualified personnel) to prevent electrical shock, personal injury or damage to equipment
- Operation of the actuator in an inappropriate fashion may cause harm or damage to the unit or surrounding equipment

The end user should take care when assessing the local ambient temperature to take into account the heat from any connecting pipe-work or inherent heat from process plant etc.

⚠ WARNING

Before installing the actuator, make sure that it is suitable for the intended application. If you are unsure of the suitability of this equipment for your installation consult Rotork prior to installation.

⚠ WARNING: ELECTRIC SHOCK HAZARD

Installation and servicing must be performed only by qualified personnel.

⚠ WARNING: ELECTROSTATIC DISCHARGE

This equipment houses static sensitive devices. To protect the internal components never touch the printed circuit boards without using electrostatic control procedures.

⚠ WARNING: ENCLOSURE MATERIALS

CMA actuator castings are manufactured from aluminium alloy with stainless steel fasteners and in the case of units fitted with UPS/Local Controls, a glass window bonded in place with cement. The user must ensure that the operating environment and any materials surrounding the actuator cannot lead to a reduction in the safe use of, or the protection afforded by the actuator. Where appropriate the user must ensure the actuator is suitably protected against its operating environment.

4.2.1 Handwheel Operation

The handwheel is located on the top cover of the CMA (all variants). Push and hold the handwheel down and rotate to extend/retract or rotate the actuator output drive.



Fig 4.1

Verify direction of output shaft rotation for clockwise operation of the handwheel. (Varies with frame size).

⚠ WARNING: OPERATING BY HAND

Note that under no circumstances should any additional lever device such as a wheel key or wrench be applied to the hand-wheel in order to develop more force when closing or opening the valve as this may cause damage to the valve and/or actuator. It may also cause the valve to become stuck in the seated or back seated position.

Model	Output When Hand Knob is Turned Clockwise
CMA - Linear	Extend or Retract
CML-100/250	Retract
CML-750	Extend
CMA - Quarter-turn	
CMQ-250	Anticlockwise
CMQ-500	Anticlockwise
CMQ-1000	Anticlockwise
CMA - Rotary	
CMR-50	Clockwise
CMR-89	Clockwise
CMR-100	Clockwise
CMR-125	Clockwise
CMR-200	Clockwise
CMR-250	Clockwise

Table 1

4. Installation & Setup

4.2.2 Standard Actuator

The standard actuator is supplied without local control knobs or external display. Removal of top cover assembly is required to adjust configuration parameters and facilitate connection of power and field wiring.



Fig 4.2

4.2.3 Local Indicator

CML has one indicator as standard. All variants can be fitted with optional extended cover with local display window.



Fig 4.3

4.2.4 Main Printed Circuit Board (PCB) Layout

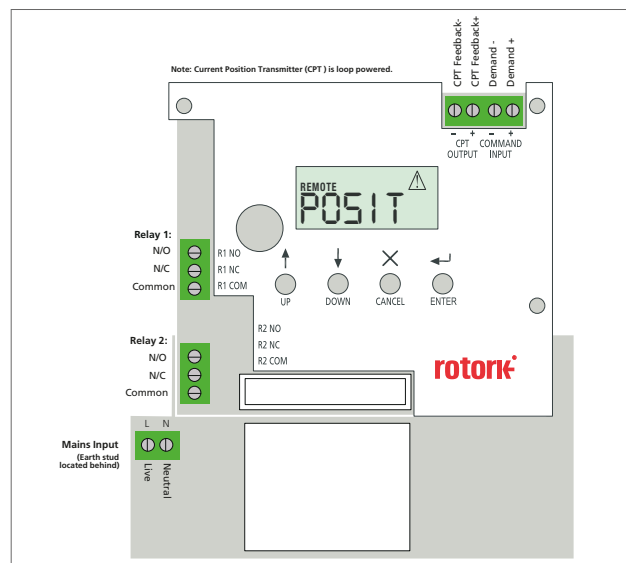

Fig 4.4 Main PCB

4. Installation & Setup

4.2.5 Local Controls & External LCD Display

Actuators can be supplied with optional local controls and an external backlit display.

Display

Removal of top cover assembly is required to adjust configuration parameters and facilitate connection of power and field wiring.

Selecting Local/Stop/Remote Operation

The Red and Black selector enables either Local or Remote control operation, lockable in each position using a padlock with a 6.5 mm hasp. When the selector is locked in the Local or Remote position the Stop facility is still available. The selector can also be locked in the Stop position to prevent electrical operation by Local or Remote control.

Local Control

With the Red/Black selector set to the Local Control (Anticlockwise) position the black selector can now be turned to select Open or Close electrical operation.

Note the actuator can be configured for 'Push to Run' or 'Self Maintained' Open and Close operation when the selector is operated.

Remote Control

Rotate the Red/Black selector to the Remote position (Clockwise). This allows the Remote control signals to operate the actuator. Local Stop can still be used by turning the Red/Black selector anticlockwise.

4.2.6 Reserve Powerpack

The actuator can be fitted with an optional 'Reserve Powerpack' consisting of super capacitors to allow the actuator to carry out predetermined electrical operation on power failure.

On power up the actuators require a charging period during which time electrical operation will be inhibited. This could take up to 3 minutes.

Note: Electrical operation is inhibited and the external LCD backlight will flash ON/OFF during the charging period.

On loss of power supply the actuator will carry out its designed fail to position. The LCD display will remain illuminated and flashes Red and White alternatively until the energy stored in the capacitors is depleted. This could take up to 30 minutes.



Fig 4.5

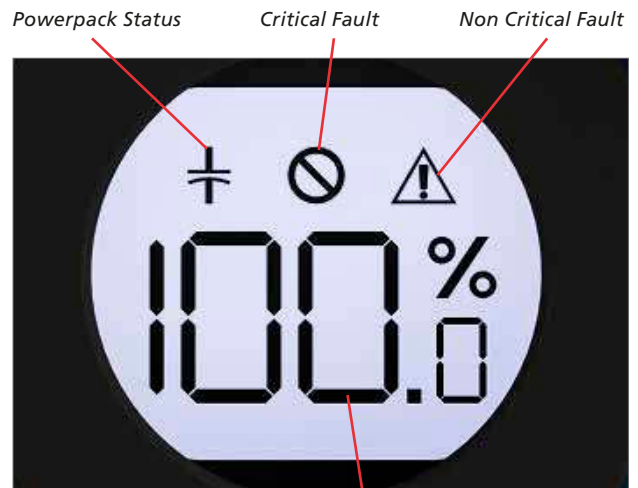

Fig 4.6



Fig 4.7 Actuator flashes Red and White alternatively when power failure occurs

4. Installation & Setup

4.2.7 LCD Display

The main PCB has a LCD Display used to show STATUS and configuration information.

On power up the default screen is the POSIT parameter.

The actuator will indicate Local or Remote mode selected in top left hand corner of the LCD.

See Basic Setup Mode for details.

4.2.8 Setup Pushbuttons

Four push button switches are located on the main PCB below its LCD Display and are used to view and change the actuator configuration parameters.

The Switch Functions are as follows:

'UP'

Used to navigate menus in view mode. Increase parameter values in Edit Mode.

'DOWN'

Used to navigate menus in view mode. Decrease parameter values in Edit Mode.

'MODE/CANCEL'

Used to exit and go to previous Menu.

ENTER

Used to enter and save changes to configuration parameters.



Fig 4.8

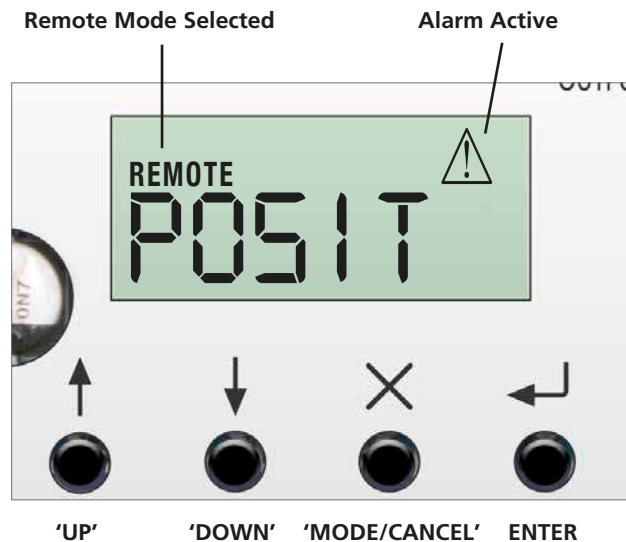

Fig 4.9

⚠️ NON-CRITICAL FAULT

An alarm condition exists which does not prohibit actuator movement.

Non-critical faults are:

- STALL
- Torque / Thrust Overload
- Loss of Communications
- Loss of Demand Signal
- Over Temperature
- Power Loss

⊘ CRITICAL FAULT

An alarm exists which prohibits actuator movement.

Critical faults are:

- Loss of Feedback
- EEPROM Fault

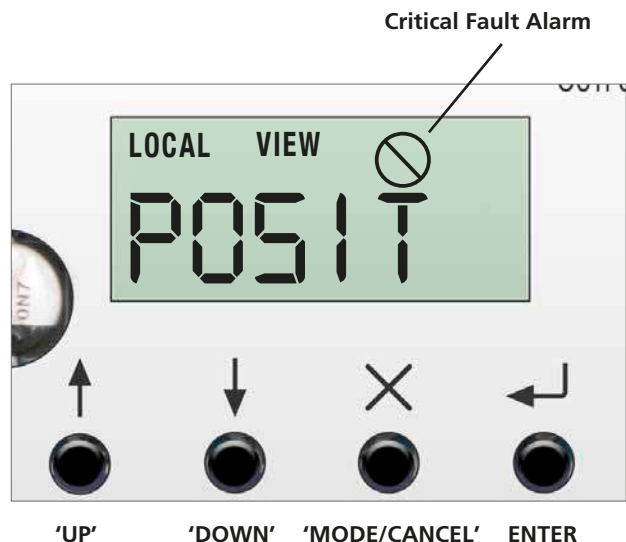

Fig 4.10

5. Mounting the Actuator – CML Linear Actuators Only

The CMA actuator is available for linear, quarter-turn or rotary valves, dampers or other devices.

Each of these applications may require different methods of mounting the actuator to the valve.

Typical examples only are described in this publication and do not cover all possible variants of valve types.

5.1 CML - Linear Unit - Mounting

⚠ CAUTION

It is essential that the actuator mounting procedure is carried out when the valve is not under working process conditions, as full valve movement may occur.

⚠ IMPORTANT

It is essential that the actuator is mounted correctly to the valve.

The height of the yoke or pillar and mounting plate, in relation to the top of the valve spindle is critical to ensure full stroke movement of the valve.

The Installation & Setup will include the following procedures:

1. Ensure valve is closed and safe (offline)
2. Actuator output shaft is retracted
3. Mount and align actuator to valve
4. Carry out basic setup

⚠ WARNING

Where actuators are fitted with Reserve Powerpack assembly please note that the actuator output shaft may move after removal of the power supply.

After disconnection of the power supply wait until the flashing Red/White External LCD display has extinguished before removal of the top cover assembly to gain access to the electrical compartment of the actuator!

⚠ WARNING

Under NO circumstances attempt to move the actuator or adjust the output drive shaft connection to the valve stem whilst the External Local display is illuminated.

DO NOT REMOVE THE TOP COVER ASSEMBLY TO GAIN ACCESS TO THE ELECTRICAL COMPARTMENT WHILST THE LOCAL DISPLAY IS ILLUMINATED.

WAIT UNTIL THE DISPLAY IS EXTINGUISHED, THIS COULD TAKE UP TO 30 MINUTES AFTER POWER DOWN.



Fig 5.11 CML-100 & CML-250



Fig 5.12 CML-750

5. Mounting the Actuator – CML Linear Actuators Only

Move Valve stem to the closed position

To enable the actuator to be installed correctly the valve must be in the closed (down) position to allow fitting of the valve stem/actuator coupling.

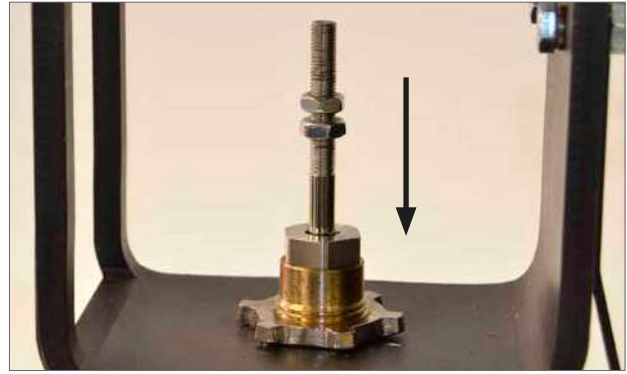

Fig 5.13

Actuator Output Shaft

The actuator is supplied with the output shaft in the fully retracted position. If the output shaft is in the extended position it may be necessary to manually operate the actuator using the handwheel to the retracted position to allow installation. Push and turn the handwheel to retract the output shaft.



Fig 5.14

Valve Stem Coupling

Machine the valve stem to actuator output shaft coupling adaptor to suit. **(NOT SUPPLIED)**

Fit the coupling to the valve stem. It may be necessary to use a locking nut to eliminate any backlash.

Leave the coupling loose and free to rotate at this stage.



Fig 5.15

CML-100 & CML-250 Units Only

Remove the locking ring from the base of the actuator and position the unit on to the valve mounting flange.

CML-750 Units

Position the actuator on to its mounting flange, fit four off fixings but do not fully tighten at this stage.



Fig 5.16

5. Mounting the Actuator – CML Linear Actuators Only

Replace the locking ring.

DO NOT FULLY TIGHTEN AT THIS STAGE.



Fig 5.17

Extend the actuator output shaft to bring the end of the shaft and the coupling together. Rotate the coupling as required to get a good firm contact between the valve stem and the output shaft.

Adjust and tighten locking nut(s) if fitted on valve stem side of the coupling. Ensure that the actuator is centrally aligned with the valve stem.

If the actuator output shaft reaches its fully extended position it will be necessary to retract the actuator shaft a sufficient distance to allow adjustment of the coupling to ensure a tight shut off in thrust seating valves.



Fig 5.18

⚠ WARNING

It is critical that there is correct alignment between actuator output shaft and the valve stem.

Note: Mis-alignment will result in increased mechanical wear and possible damage to the valve stem.

CML-100 & CML-250 Units only

Tighten the locking ring fully to secure the actuator in position. Push and turn the manual override to verify correct operation of the valve.

Refer to Table 1 on page 9.

CML-750 Units

Tighten the four fixings fully.



Fig 5.19

Go to page 21 for electrical installation and basic setup instructions.

6. Mounting the Actuator – CMQ Quarter-Turn Actuators Only

6.1 CMQ - Quarter-Turn Unit - Mounting

CAUTION

It is essential that mounting procedure is carried out when the valve is not under working process conditions, as full valve movement may occur.

IMPORTANT

It is essential that the actuator is mounted correctly to the valve, damper or other device.

The Installation & Setup will include the following procedures:

1. Prepare the drive coupling
2. Ensure valve position is noted and safe (offline)
3. Mount and align actuator to valve
4. Adjust actuator stop bolts
5. Carry out basic setup

WARNING

Where actuators are fitted with Reserve Powerpack assembly please note that the actuator output shaft may move after removal of the power supply.

After disconnection of the power supply wait until the flashing Red/White External LCD display has extinguished before removal of the top cover assembly to gain access to the electrical compartment of the actuator!

WARNING

Under NO circumstances attempt to move the actuator or adjust the output drive shaft connection to the valve stem whilst the external local display is illuminated.

DO NOT REMOVE THE TOP COVER ASSEMBLY TO GAIN ACCESS TO THE ELECTRICAL COMPARTMENT WHILST THE LOCAL DISPLAY IS ILLUMINATED.

WAIT UNTIL THE DISPLAY IS EXTINGUISHED, THIS COULD TAKE UP TO 30 MINUTES AFTER POWER DOWN.

Actuator Stop Bolts

The quarter-turn CMQ actuators have two end of travel stop bolts adjustable between 80 to 100° of travel rotation.

The stop bolts are set to a nominal 90° of travel at the factory. These must be adjusted to suit the required valve travel BEFORE attempting to set the electrical travel limits.

The clockwise end of travel stop bolt is on the right as viewed in Fig 6.2.



Fig 6.1



Fig 6.2

6. Mounting the Actuator – CMQ Quarter-Turn Actuators Only

Securing Actuator to Valve

Before fitting actuator to the valve ensure that the actuator and valve are in the same position. The position of the actuator can be confirmed by using the handwheel.

A suitable mounting flange conforming to ISO 5211 or USA standard MSS SP-101 depending on the actuator supplied must be provided to mount the unit to the valve top works assembly.

Actuator to mounting flange assembly fixings must conform to Material Specification ISO Class 8.8. Delta GZ coated Grade A4 stainless steel fixings are recommended.

Actuator is supplied with a square output drive shaft. A coupling and adaptor bracket is required to mate the actuator to the valve stem.

Fig 6.5 shows a typical valve adaptation kit.

Fit suitable mounting brackets and adaptors to the valve body.

Ensure that valve stem and actuator output shaft are in the same position (Open or Closed).

Align the actuator output shaft with stem adaptor.

Position actuator on to the valve mounting flange. It may be necessary to adjust the position of the actuator to enable alignment of the fixing bolts.

Tighten base fixings in accordance with Table 2.

Thread Size	Torque Nm	Torque lbf.ft
5/16 UNC	14	9.5
M8	14	9.5

Table 2

Push and turn the manual override to verify correct operation of the valve.

Refer to Table 1 on page 9.

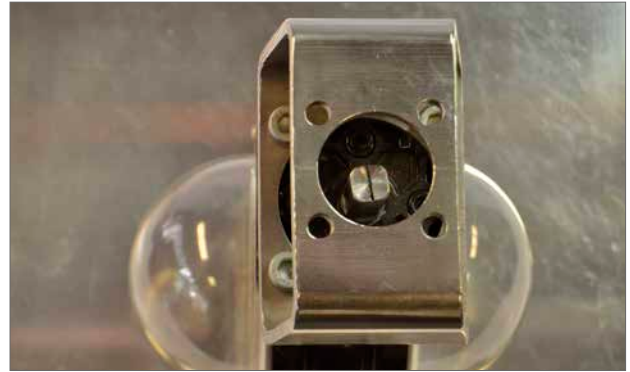

Fig 6.3



Fig 6.4



Fig 6.5

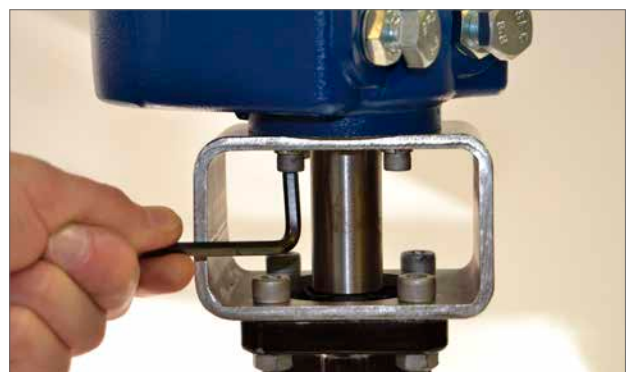

Fig 6.6

6. Mounting the Actuator – CMQ Quarter-Turn Actuators Only

Stop Bolt Adjustment

It is recommended that stop bolt adjustment be carried out by the valvemaker/supplier before the valve is fitted in to the pipework.

Once installed the valvemaker/supplier should be consulted before stop bolt re-adjustment is carried out. After setting or adjustment of stop bolts the actuator limits must be reset.

The CMA stop bolts are located on the lower body assembly. The stop bolt adjustment allows +/- 5° variation of travel at each end position. Screwing bolts in reduces the range of movement, out increases range of movement.

For clockwise closing valves the right hand bolt is the closed stop as shown in Fig 6.8. The left hand bolt is the open stop.

Stop bolts are factory set to give a nominal travel of 90°.

Adjustment for Non Seating Valve Types

For closed and open stop position adjustment. Undo stop bolt locknut. Move actuator and valve to the required stopping position (it may be necessary to unscrew stop bolt to allow more travel). Screw stop bolt in until a stop is felt. Tighten stop bolt lock nut.

Adjustment for Seating Valve Types

Undo stop bolt locknut. Move actuator and valve to the required stopping position (it may be necessary to unscrew stop bolt to allow more travel). Screw stop bolt in until a stop is felt and then back off by 1 to 3 turns. Tighten stop bolt lock nut.

Go to page 21 for electrical installation and basic setup instructions.



Fig 6.7



Fig 6.8

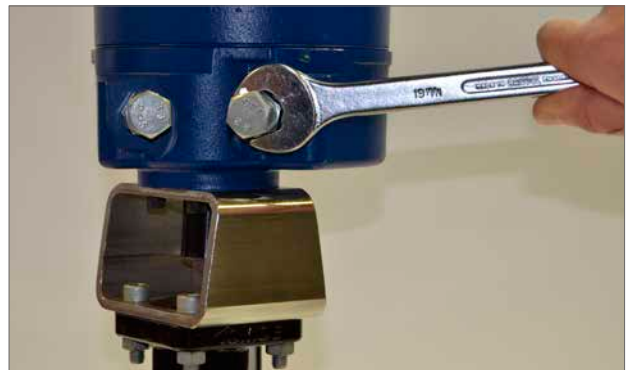

Fig 6.9

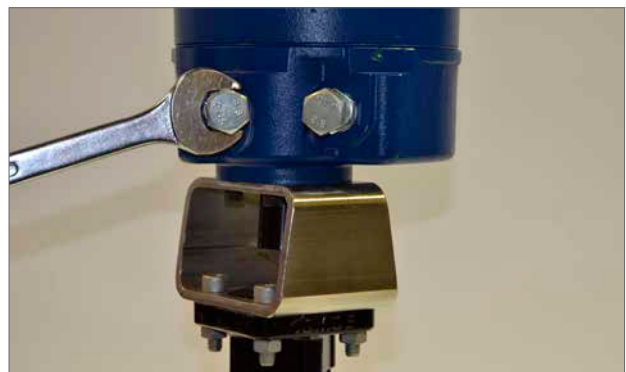

Fig 6.10

7. Mounting the Actuator – CMR Rotary Actuators Only

7.1 CMR - Rotary (Multi-Turn) Unit Mounting (Non-Thrust)

CAUTION

It is essential that mounting procedure is carried out when the valve is not under working process conditions, as full valve movement may occur.

IMPORTANT

It is essential that the actuator is mounted correctly to the valve, damper or other device.

The Installation & Setup will include the following procedures:

1. Prepare the drive coupling
2. Ensure valve position is noted and safe (offline)
3. Mount and align actuator to valve/pump
4. Carry out basic setup

A suitable mounting flange must be provided to mount the unit to the valve top works assembly. Mounting flange assembly fixings must conform to Material Specification ISO Class 8.8. Delta GZ coated Grade A4 stainless steel fixings are recommended. CMA Rotary actuators are supplied with base assembly suitable for Non-Thrust applications requiring between 180° and 320 turns operation. For applications that require thrust to be taken by the actuator apply to Rotork.

Drive Coupling

Machine and fit coupling adaptor to the actuator output shaft and secure appropriately.

Align and Mount Actuator

Ensure that the actuator/stem coupling is aligned correctly with the stem of the valve or actuated device. Mount the actuator to the flange adaptor, ensure that the actuator is central and there is no mis-alignment between the coupling and shaft.



Fig 7.1



Fig 7.2

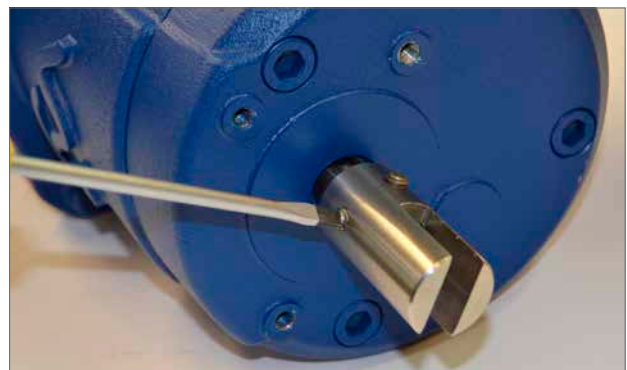

Fig 7.3

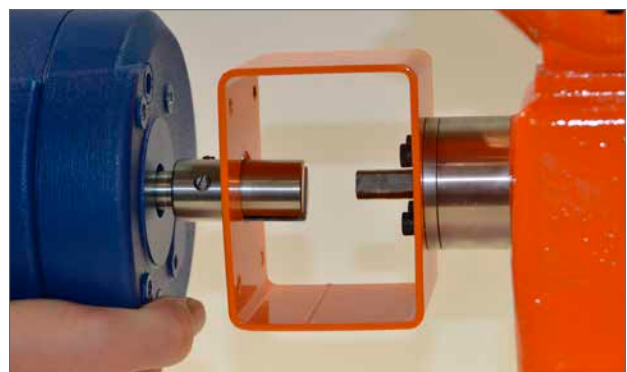

Fig 7.4

7. Mounting the Actuator – CMR Rotary Actuators Only

Tighten base fixings in accordance with Table 3.

Thread Size	Torque Nm	Torque lbf.ft
5/16 UNC	14	9.5
M8	14	9.5

Table 3

Push and turn the manual override to verify correct operation of the valve.

Refer to Table 1 on page 9.

Go to page 21 for electrical installation and basic setup instructions.

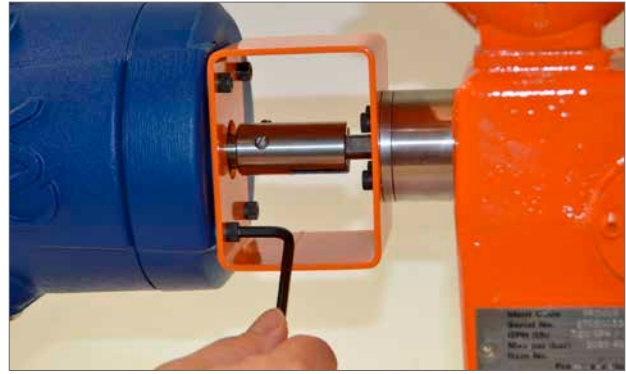

Fig 7.5



Fig 7.6

8. Installation & Setup – All CMA Units

8.1 Electrical Installation

8.1.1 Cable Entries

The cable entries are tapped either ¾" NPT or M25. Remove any transit plugs. Make off cable entries appropriate to the cable type and size. Ensure that threaded adaptors, cable glands or conduit are tight and fully waterproof. Seal unused cable entries with steel or brass threaded plugs.

If the actuator is to be installed in a hazardous area, a suitably certified cable gland must be fitted with the use of a certified thread adaptor where appropriate.

Unused entries must be closed with a suitably certified stopping plug.

Wire type must meet local and certifying agency (CSA, IEC Ex, ATEX, etc) requirements and have a minimum temperature rating of 88 °C.

Wiring installation must comply with local statutory regulations.

8.1.2 Connecting to Terminals

The wiring diagram supplied is particular to each actuator and must not be interchanged with any other actuator. If in doubt check the wiring diagram number with that on the actuator.

Refer to the wiring diagram to identify functions of terminals. Check that the supply voltage is the same as that marked on the actuator nameplate.

8.1.3 Cover Removal Precautions

⚠ WARNING

Where actuators are fitted with Reserve Powerpack assembly please note that the actuator output shaft may move after removal of the power supply.

After disconnection of the power supply wait until the flashing Red/White External LCD display has extinguished before removal of the top cover assembly to gain access to the electrical compartment of the actuator!

⚠ WARNING

Under NO circumstances attempt to move the actuator or adjust the output drive shaft connection to the valve stem whilst the External Local display is illuminated.

DO NOT REMOVE THE TOP COVER ASSEMBLY TO GAIN ACCESS TO THE ELECTRICAL COMPARTMENT WHILST THE LOCAL DISPLAY IS ILLUMINATED.

WAIT UNTIL THE DISPLAY IS EXTINGUISHED, THIS COULD TAKE UP TO 30 MINUTES AFTER POWER DOWN.



Fig 8.1



Fig 8.2 Actuator set to 'STOP' position



Fig 8.3 Actuator display flashes Red and White when RPP is active during power failure.

8. Installation & Setup – All CMA Units

8.1.4 Electrical Installation

WARNING

Ensure all power supplies are isolated before removing actuator covers.

Check that the supply voltage agrees with that stamped on the actuator nameplate. A fused switch or circuit breaker must be included in the wiring installation of the actuator. The switch or circuit breaker must be installed as close as possible to the actuator and shall be marked to indicate that it is the disconnecting device for that particular actuator. Actuator must be mounted such that it is not difficult to operate the disconnecting device.

The actuator must be protected with an over current protection device rated in accordance with PUB094-006 which details the electric motor performance data for CMA range actuators.

8.1.5 Earth Ground Connections

A lug is cast adjacent to the conduit entries for attachment of an external protective Earth (Ground) cable. An internal earth terminal is also provided. Consult local and certifying agency codes to determine which earth connectors is to be used. See Fig 8.4.

8.1.6 Removing Terminal Cover

Using a 6 mm Allen key loosen the captive fixings securing the terminal compartment cover. Do not attempt to lever off the cover with a screwdriver as this will damage the o-ring seal and may damage the flamepath on a certified unit.

If necessary locate the two set screws Fig 8.5 and use them to lift the cover away from its seat.

Note: Actuators fitted with Local Controls or Reserve Power pack have internal wiring loom connectors between the top cover assembly and the main PCB. See Fig 8.8.

When removing the top cover assembly support the weight of the cover and disconnect the wiring loom plug from the socket located on the main chassis plate before completely removing the cover.



Fig 8.4



Fig 8.5



Fig 8.6



Fig 8.7

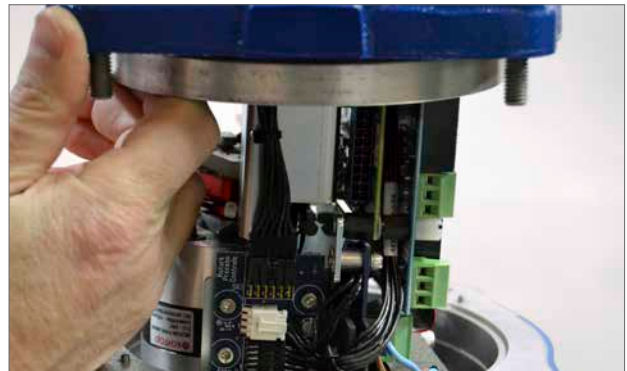

Fig 8.8

8. Installation & Setup – All CMA Units

8.1.7 Installation Wiring

Route cabling through the most appropriate conduit entry making sure that cables will not foul on the cover assembly or internal components after refitting. Refer to the actuator wiring diagram for connection details.

Wire type must meet local and certifying agency (CSA, IEC Ex, ATEX, etc) requirements and have a minimum temperature rating of 88 °C.

Terminate the power, control and indication wiring with appropriate ferrules. Connect wiring to the terminal block connectors. Ferrules for power connector must be Phoenix Contact AI 2,5 - 8 or AI 1,5 - 8 series ferrules or equivalent with a temperature range of -40 to +105 °C, a minimum current rating of 5 A across the temperature range and approved for field wiring purposes. Take care to route the wiring away from the spigot housing on the gearcase.

NOTE: RIRO Option.

For ease of wiring the use of 18 AWG wire for remote control and indication connections is recommended.

⚠ WARNING: The actuator must be checked to ensure that the voltage specified on the actuator identification nameplate matches the supply voltage.

CMA is configured at the factory for use with one of the following power supply voltages:

Single-Phase 50 Hz / 60 Hz	110, 115, 120, 208, 220, 230, 240 VAC
DC	24 VDC Only ===

Supply voltage fluctuations not to exceed +/- 10% of the nominal supply voltage.
Supply frequency tolerance +/- 10%.

8.1.8 Fuses

Fuse is a 5 x 20, slow acting, glass type with a 250 volt rating. Use only a 1 amp fuse for AC units and a 2.5 amp device for DC units.

8.1.9 Relays

Each relay features Normally Open (N/O) and Normally Closed (N/C) volt-free contacts. Due to the constraints of the Low Voltage Directive, the maximum allowable voltage that can be applied to the relay terminals is 150 VAC. For DC however, the maximum voltage that can be applied is 30 VDC. Rated Current is 3 A.

8.1.10 CPT Feedback

The Loop-powered transmitter provides 4 to 20 mA signal that corresponds to position. Loop supply is 24 VDC nominal (18-30 VDC max).

8.1.11 Demand

The 4-20 mA command signal is used to control actuator position.



Fig 8.9



Fig 8.10



Fig 8.11 Actuator identification label

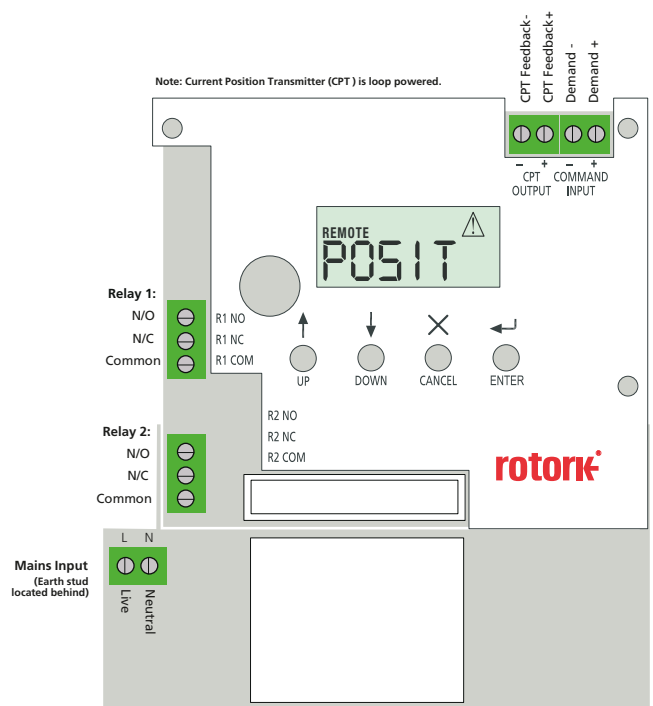

Fig 8.12 Main PCB

9. Basic Setup

9.1 Basic Setup

Basic setup is required once the actuator has been mounted on to the valve.

Procedures include:

- Step 1 Select Local Operation
- Step 2 Set Output Torque/Thrust
- Step 3 Select Action at End of Travel (Limit or Force)
- Step 4 Set Close Limit of Travel
- Step 5 Set Open Limit of Travel
- Step 6 Calibrate Command Signal Zero Setpoint
- Step 7 Calibrate Command Signal Span Setpoint

The Basic Setup procedure is carried out by using the 4 pushbutton switches mounted below the LCD display on the main PCB.

NOTE: SETTINGS CAN ONLY BE CHANGED WITH THE ACTUATOR SET TO LOCAL OPERATION.



Fig 9.1

9. Basic Setup

9.2 Basic Menu Structure

	BASIC
POSITION	POSIT Position
SETPOINT	SET PT Setpoint
THRUST or TORQUE	THRUST or TORQUE Thrust Display or Output Torque
LOCAL/REMOTE OPERATION	LOCREM Local / Remote Operation
MANJOG	MANJOG Manual Jog
CLOSE TORQUE/THRUST	TORQ/THRSTC Close Torque/Thrust
OPEN TORQUE/THRUST	TORQ/THRSTO Open Torque/Thrust
CLOSE ACTION	CL ACT Close Action
OPEN ACTION	OP ACT Open Action
CLOSE LIM	CL LIM Close Limit (zero)
OPEN LIMIT	OP LIM Open Limit (span)
FIELD COMMAND SIGNAL 4	CMD4 Field Command Signal4
FIELD COMMAND SIGNAL 20	CMD20 Field Command Signal20
COMMAND INVERT	CMD IV Command Invert
TRANSMITTER INVERT	CPT IV Transmitter Invert
DEADBAND	DBAND Deadband
STATUS	STATUS
FAULT HISTORY	FLTHST Fault History Access
ADV MENU ACCESS	ADVANC Advanced Menu
DEFAULTS	DEFLTS Default Menu Access

9. Basic Setup

9.3 Basic Setup Flowchart

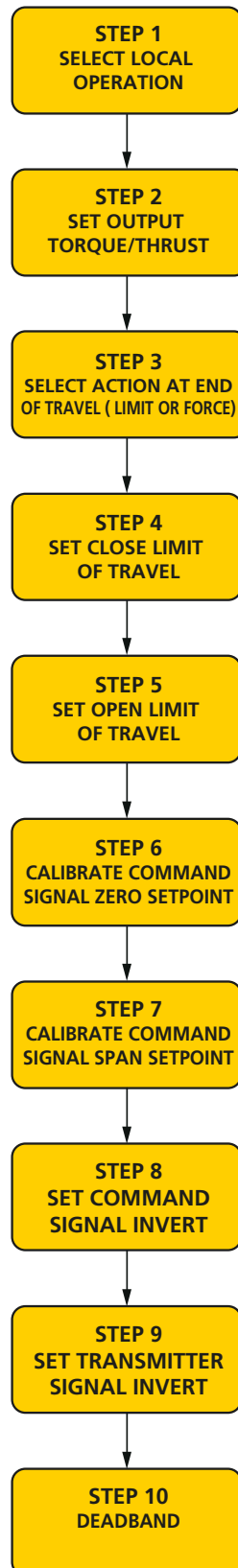

9. Basic Setup

STEP 1
SELECT LOCAL
OPERATION

9.4 Select Local Operation

Screen shows the actuator set to Remote operation mode with alarms active. The actuator must be set to Local operation mode before the travel limits can be set.

Using the 4 push button switches mounted below the LCD.

PRESS 'DOWN'

SETPOINT parameter is now displayed.

Press ENTER to view the current setpoint if required.

PRESS 'DOWN'

THRUST or TORQUE parameter is now displayed depending on actuator type CML, CMQ, CMR.

Press ENTER to view current Thrust or Torque output value.

If these settings are correct and do not require adjustment move on to step 4 to set the close limit.

LOCAL/REMOTE parameter is now displayed.



Fig 9.2



Fig 9.3



Fig 9.4



Fig 9.5

9. Basic Setup

9.4 Select Local Operation (cont'd)

PRESS ENTER

The display now goes in to VIEW mode.

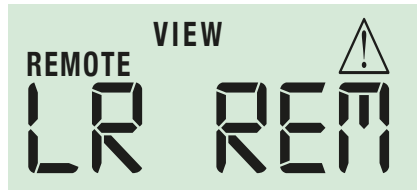

Fig 9.6

PRESS ENTER

The display now goes in to EDIT mode.



Fig 9.7

Use the UP or DOWN button to scroll through the settings until LR LOC is displayed.

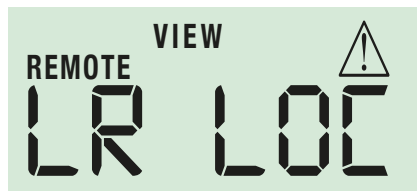

Fig 9.8

PRESS ENTER

The actuator is now selected to LOCAL Operation mode and the change is acknowledged as 'SAVED'.



Fig 9.9

Press CANCEL to go back to top level menu.



9. Basic Setup

STEP 2
SET OUTPUT
TORQUE/THRUST

9.5 Set Output Torque/Thrust

Before operating the actuator electrically it may be necessary to reduce the output torque or thrust of the actuator to prevent valve becoming jammed at the end of travel during setup.

Use UP/DOWN buttons until TORQ C or THRSTC is displayed.

Press ENTER to view the Close output Torque or Thrust set value.

The Torque or Thrust Output is adjustable between 60% and 150% of its rated value.

Fig 9.11 shows the Closing Torque value set to 60% of its rated value.

NOTE: When the Torque/Thrust is selected above the 100% Rated value this additional effort is only available at the end of travel to seat the valve for tight shut off applications.

NOTE: The output Torque or Thrust setting must be sufficient to operate the valve under full working process conditions.



Fig 9.10

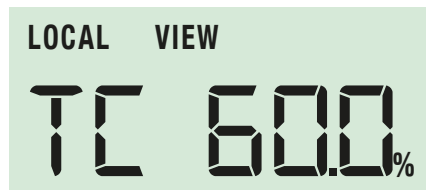

Fig 9.11

9. Basic Setup

9.5 Set Output Torque/Thrust (cont'd)

If the Close Torque/Thrust value requires adjustment press ENTER.

The actuator is now in EDIT Mode and the parameters can be modified.

Use the UP/DOWN buttons until the correct Torque/Thrust Value is displayed.

Press ENTER to save the changes. Visually confirm that the parameter is saved.

Press CANCEL to return to previous menu.

Use UP/DOWN buttons until TORQ O or THRSTO is displayed.

Press ENTER to view the Open output Torque or Thrust set value.

The Torque or Thrust Output is adjustable between 60% and 150% of its rated value.

Fig 9.16 shows the Opening Torque value set to 100% of its rated value.

Press ENTER to change the Open Torque or Thrust set value.

NOTE: When the Torque/Thrust is selected above the 100% Rated value this additional effort is only available at the end of travel to seat the valve for tight shut off applications.

NOTE: The output Torque or Thrust setting must be sufficient to operate the valve under full working process conditions.

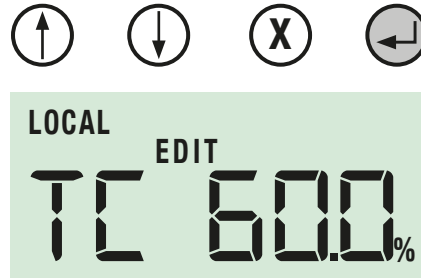

Fig 9.12

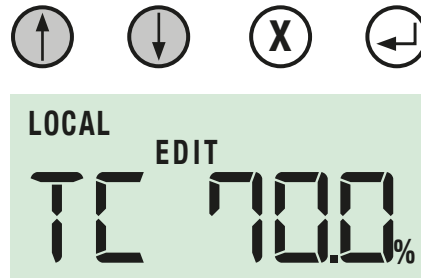

Fig 9.13

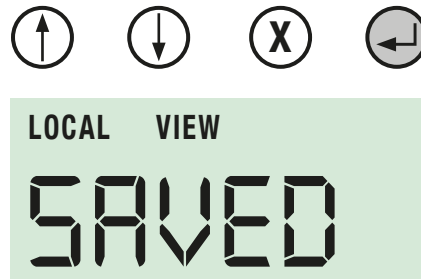

Fig 9.14

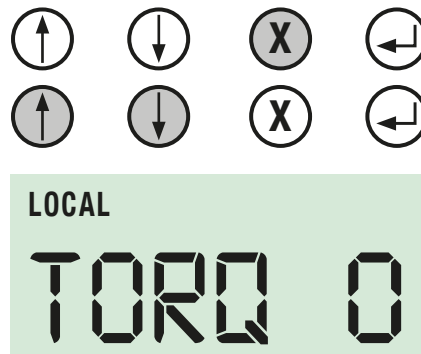

Fig 9.15

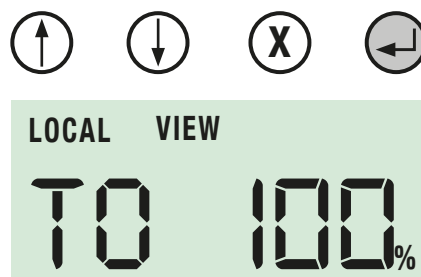

Fig 9.16

9. Basic Setup

9.5 Set Output Torque/Thrust (cont'd)

The actuator is now in EDIT Mode and the parameters can be modified.

Use the UP/DOWN buttons until the correct Torque/Thrust Value Is displayed.

Press ENTER to save the changes. Visually confirm that the parameter is saved.

NOTE: The Output Torque or Thrust setting must be sufficient to operate the valve under full working process conditions.

Press CANCEL to return to previous menu.

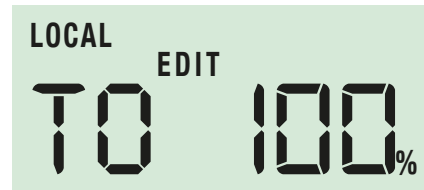

Fig 9.17

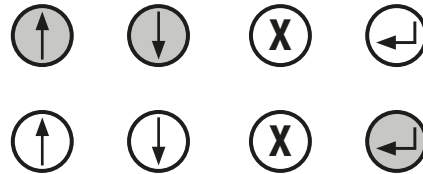

Fig 9.18



Fig 9.19



Fig 9.20



STEP 3
SELECT ACTION AT END
OF TRAVEL (LIMIT OR FORCE)

9.6 Select Action at End of Travel

The actuator can be configured to stop on position limit at the end of travel where valves do not require torque or thrust to be applied to the valve seat.

To provide tight shut off at end of travel the actuator can be configured to apply its configured torque or thrust to the valve seat in either direction.

Use the UP/DOWN buttons until CL ACT is displayed.

Press ENTER to view the Close Action setting.

9. Basic Setup

9.6 Select Action at End of Travel (cont'd)

CA LIM shows the actuator is set for Position Limit action at the Closed end of travel.

To change the end of travel action press ENTER.

The actuator is now in EDIT Mode.

Use the UP/DOWN buttons to select the required end of travel action.

Fig 9.23 shows the Closed End of Travel Action set to FRC (FORCE) and the set output closing torque or thrust will be applied to the valve seat at the end of travel.

Press ENTER to save any changes.

Press CANCEL to return to previous menu.

NOTE Ensure that any changes to parameters are SAVED before returning to VIEW Mode.

Use the UP/DOWN Buttons to select the Open Action (OP ACT) and repeat the procedure to select the Action at End of Travel.

AFTER SAVING ANY CHANGES PRESS CANCEL UNTIL YOU HAVE RETURNED TO THE TOP LEVEL BASIC MENU AND POSIT IS DISPLAYED.



Fig 9.26

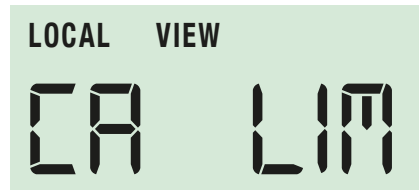

Fig 9.21



Fig 9.22



Fig 9.23



Fig 9.24

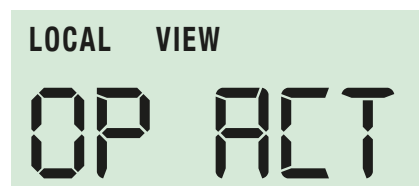

Fig 9.25

9. Basic Setup

STEP 4
SET CLOSE LIMIT
OF TRAVEL

9.7 Set Closed Limit of Travel

To set the Closed limit of travel for the actuator press the DOWN button until CL LIM is displayed.



Fig 9.27

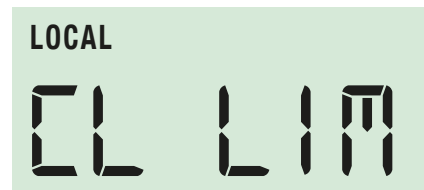

Fig 9.28

Press ENTER to put the actuator in to EDIT Mode. This will allow parameter changes to be made.

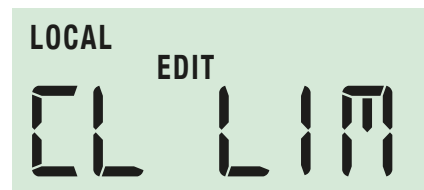

Fig 9.29

Use the UP and DOWN buttons to move the actuator output drive to the required CLOSED Position.



Press ENTER and the new CLOSED End of Travel Limit is saved to the actuators memory.



Fig 9.30

THE CLOSED END OF TRAVEL LIMIT IS SET.



Press CANCEL to go back to top level menu.

9. Basic Setup

STEP 5
SET OPEN LIMIT
OF TRAVEL

9.8 Set Open Limit of Travel

Press the DOWN arrow until the OP LIM menu is displayed.



Fig 9.31



Fig 9.32

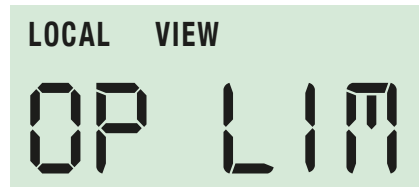

Fig 9.33



Press ENTER to put the actuator in to EDIT Mode.
This will allow parameter changes to be made.



Fig 9.34



Use the UP and DOWN buttons to move the actuator output drive to the required OPEN position.

Press ENTER and the new OPEN End of Travel Limit is saved to the actuators memory.

THE OPEN END OF TRAVEL LIMIT IS SET.



Fig 9.35



Press CANCEL to go back to top level menu.

9. Basic Setup

STEP 6
CALIBRATE COMMAND
SIGNAL ZERO SETPOINT

9.9 Calibrate Command Signal Zero Setpoint

After the open/close limit is set the 4 to 20 mA signal is automatically calibrated to those positions. The 4 mA input command will send you to CLOSED LIMIT, the 20 mA and will send you to OPEN LIMIT. However to calibrate to field signal follow page 36.

9.9.1 Basic Setup

The CMA proportional controller enables the actuator to automatically position a valve or actuated device in proportion to an analogue mA current. A signal derived from the actuator position feedback is compared with a signal proportional to the input signal. The difference (error) is used to energize the motor and drive the output to the required position to cancel the error.

Unwanted frequent operation can be prevented by adjustment of the deadband.

NOTE: The 4 mA command signal is automatically referenced to the fully closed limit position. If necessary reverse the limits of travel to achieve the desired command signal response.



Fig 9.36

9. Basic Setup

STEP 6
CALIBRATE COMMAND
SIGNAL ZERO SETPOINT

9.9.2 Calibrate Command Signal Zero Setpoint Using an External 4-20 mA Signal

Press the DOWN arrow until the CMD 4 menu is displayed.



Fig 9.37



Fig 9.38

Press ENTER until 'EDIT' is displayed.



Apply LOW setpoint signal (4 mA).



Fig 9.39

Press ENTER.

The actuator Zero setpoint is automatically calibrated to the applied analogue signal.



Fig 9.40

Press CANCEL to go back to top level menu.



Fig 9.41

9. Basic Setup

STEP 7
CALIBRATE COMMAND
SIGNAL SPAN SETPOINT

9.9.3 Calibrate Command Signal Span Setpoint Using an External 4-20 mA SIGNAL

Press the DOWN arrow until the CMD 20 menu is displayed.



Fig 9.42

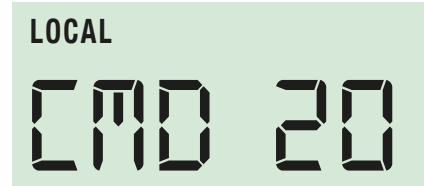

Fig 9.43

Press ENTER until 'EDIT' is displayed.

Apply HIGH setpoint signal (20 mA).



Fig 9.44

Press ENTER.

The actuator SPAN setpoint is automatically calibrated to the applied analogue signal.



Fig 9.45

Press CANCEL to go back to top level menu.



Fig 9.46

9. Basic Setup

STEP 8
SET COMMAND
SIGNAL INVERT

9.10 Set Command Signal Invert

Press the DOWN arrow until the CMD IV menu is displayed.



Fig 9.47

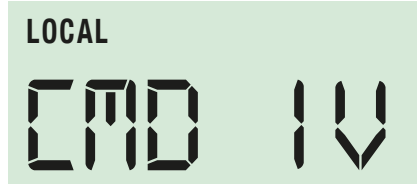

Fig 9.48



Press ENTER until 'EDIT' is displayed.

Screen shows Command Signal Invert set to OFF.

Command Signal Invert is adjustable to ON or OFF.



Fig 9.49



Use the UP/DOWN buttons to set the Command Signal Invert ON or OFF.

Set to OFF for 4 mA as the close position and 20 mA as the open position.

Set to ON to invert the signal, 4 mA is open and 20 mA is close.



Fig 9.50



Press ENTER to save the current Command Signal Invert setting.



Fig 9.51



Press CANCEL to go back to top level menu.

9. Basic Setup

STEP 9
SET TRANSMITTER
SIGNAL INVERT

9.11 Set Transmitter Signal Invert

Press the DOWN arrow until the CPT IV menu is displayed.



Fig 9.52



Fig 9.53



Press ENTER until 'EDIT' is displayed.

Screen shows Transmitter Signal Invert set to OFF.

Transmitter Signal Invert is adjustable to ON or OFF.



Fig 9.54



Use the UP/DOWN buttons to set the Transmitter Signal Invert ON or OFF.

Set to OFF for 4 mA as the close position and 20 mA as the open position.

Set to ON to invert the signal, 4 mA is open and 20 mA is close.



Fig 9.55



Press ENTER to save the current Transmitter Signal Invert setting.



Fig 9.56



Press CANCEL to go back to top level menu.

9. Basic Setup

STEP 10
DEADBAND

9.12 Set Deadband

Press the DOWN arrow until the DBAND menu is displayed.



Fig 9.57



Fig 9.58



Press ENTER until 'EDIT' is displayed.

Screen shows the Deadband set to 0.1%.

Deadband is adjustable between 0 to 10% of the Analogue signal.



Fig 9.59



Use the UP/DOWN buttons to select the desired Deadband.

Select the value of Deadband that gives the required control response.

It may be necessary to increase the deadband if the actuator 'Hunts' or overshoots the command setpoint giving spurious operation.

Press ENTER to save the current Deadband Value.



Fig 9.60



Press CANCEL to go back to top level menu.



Fig 9.61



9. Basic Setup

9.13 Completing Basic Setup

⚠ WARNING

**IF NO FURTHER SETTING IS REQUIRED
THE ACTUATOR MUST BE SET TO REMOTE
OPERATION MODE BEFORE REFITTING COVER!**



Fig 9.62

For further information on the Basic and Advanced setting menus refer to section 10.

If no further adjustment is necessary the top cover can now be replaced.

REFIT TOP COVER ASSEMBLY

⚠ WARNING

**ISOLATE ALL ELECTRICAL SUPPLIES BEFORE
REASSEMBLY.**

⚠ CAUTION

**REASSEMBLY WITH THE TOP COVER INCORRECTLY
ALIGNED MAY RESULT IN DAMAGE TO THE ELECTRONIC
AND MANUAL OVERRIDE COMPONENTS.**



Fig 9.63

Visually check the alignment of the cover and the Handwheel shaft with its original orientation.

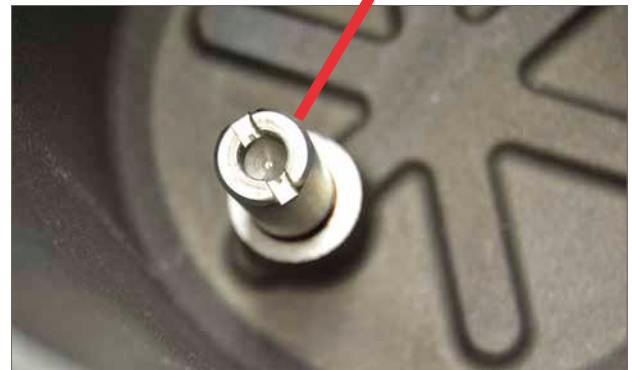

Fig 9.64

As you look at the LCD window, replace the housing so that the Rotork logo can be read on the cover right side up.



Fig 9.65

9. Basic Setup

9.13 Completing Basic Setup (cont'd)

Ensure that the spigot face is clean and greased with the o-ring seal fitted and in good condition.

Note: Actuators fitted with Local Controls or Reserve Power Pack only.

Reconnect wiring loom between the main PCB and the top cover before replacing the assembly.



Fig 9.66

Carefully align the cover assembly and handwheel shaft.

Ensure that all wiring is fitted correctly and will not foul the top cover assembly once fitted.

Lower the top cover in to place. Check operation of the handwheel and that no cables are trapped.

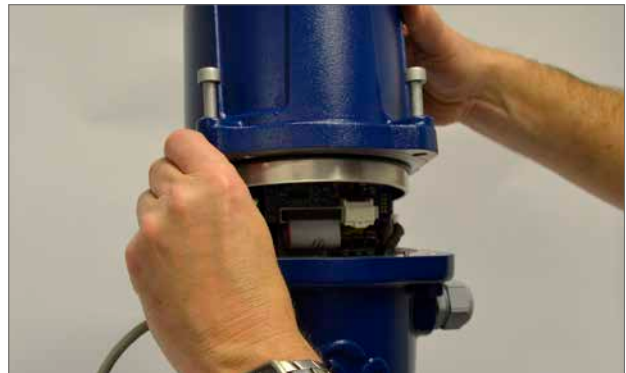

Fig 9.67

Tighten the four cap head screws.



Fig 9.68

10. Menu Structure

10.1 Menu Structure

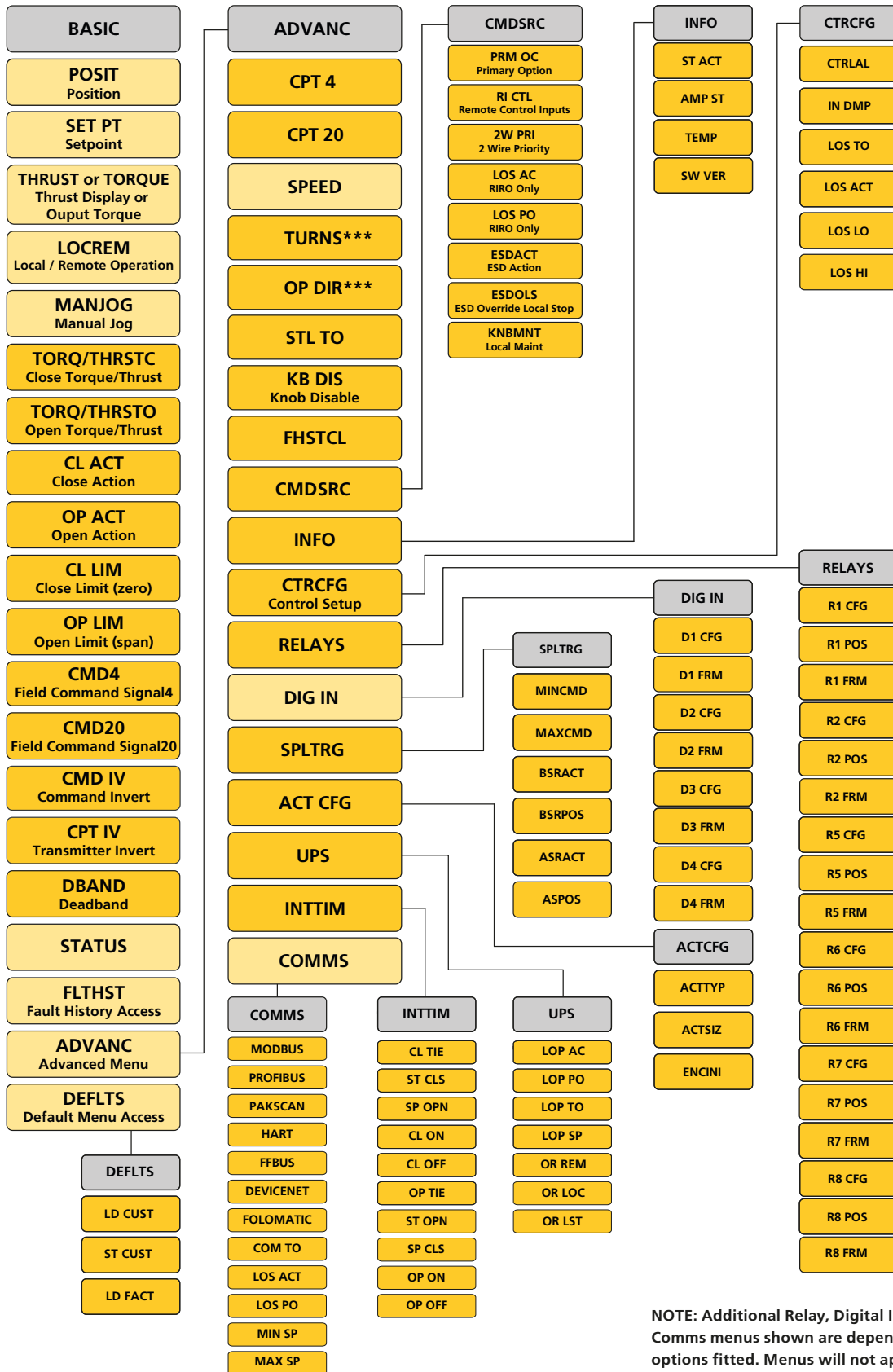

NOTE: Additional Relay, Digital Inputs and Comms menus shown are dependant on options fitted. Menus will not appear unless option is fitted.

*** Note these menus only apply to CMR units.

11. Status Alarm Menu

STATUS

11.1 Status Indication

The actuator status can be monitored in both Local and Remote control modes.

Enter the VIEW mode to display current actuator status.

Use the UP/DOWN Pushbuttons to scroll through currently active alarms and status.

Fig 11.2 indicates that the actuator is selected for remote operation and a Loss of signal demand alarm is currently active.

See below for full list of possible Status & Alarm conditions.

LOS DM

LOS DM - LOS Demand

The input demand signal is outside the minimum or maximum range defined by the LOS LO and LOSS HI set parameters.

LOS FB

LOS FB - LOS Feedback

Loss of internal position feedback. Actuator will lock in place.

STL OP

STL OP - Stall Opening

Motor stalled in Open direction. Manually operate or drive the actuator in the closed direction to clear the alarm.

STL CL

STL CL - Stall Closing

Motor stalled in Closed direction. Manually operate or drive the actuator in the open direction to clear the alarm.

OTQ OP

OTQ OP - Over Torque Opening

Max Torque exceeded in Open direction. Manually operate or drive the actuator in the closed direction to clear the alarm.

OTH OP

OTH OP - Over Thrust Opening

Max Thrust exceeded in Open direction. Manually operate or drive the actuator in the closed direction to clear the alarm.



Fig 11.1

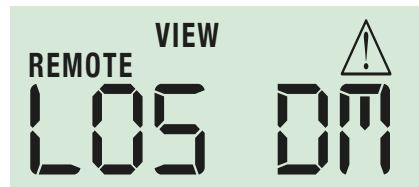

Fig 11.2

OTQ CL

OTQ CL - Over Torque Closing

Max Torque exceeded in Closed direction. Manually operate or drive the actuator in the open direction to clear the alarm.

OTH CL

OTH CL - Over Thrust Closing

Max Thrust exceeded in Closed direction. Manually operate or drive the actuator in the open direction to clear the alarm.

11. Status Alarm Menu

STATUS

11.1 Status Indication (cont'd)

OVTEMP

OVTEMP - Over Temperature

Internal Temperature Sensor Tripped.

LOSCOM

LOSCOM - Loss of Remote Bus Communications

Loss of serial bus communications greater than the COM TO communications time out period has occurred.

LOCAL

LOCAL - Local Control Selected

Actuator is selected for Local Operation. The actuator will not respond to remote commands. Local operation must be selected to modify parameters.

CL LIM

CL LIM - At Closed Limit

The actuator position is at or below the closed end of travel limit.

OP LIM

OP LIM - At Open Limit

The actuator position is at or above the open end of travel limit.

ESD

ESD - Emergency Shutdown active

Emergency Shut Down (ESD) command is active. The actuator will not respond to any other commands until the ESD condition is removed.

MONRLY

MONRLY - Monitor Relay Tripped

Monitor Relay tripped and actuator is not available for remote control.

R1 ENR

R1 ENR - Relay 1 Energised

R2 ENR

R2 ENR - Relay 2 Energised

DITHER

DITHER - Dither

Notification is generated when the actuator has performed more than 2,000, 1% position changes (or starts) per hour.

EE FLT

EE FLT - EEPROM Parameters

EEPROM parameters out of range.

Actuator is disabled , restore defaults and check basic and advanced parameters.

EC FLT

EC FLT - EEPROM Fault Customer Defaults

Customer defaults stored incorrectly or corrupted in the EEPROM. Actuator runs. Cycle the power and restore the customer defaults to remove the alarm.

EF FLT

EF FLT - EEPROM Factory Defaults

Actuator runs. Cycle power to remove the alarm. If problem persists contact Rotork.

12. Fault History Menu

FLTHST
Fault History Access

12.1 Fault History

Alarms and Faults are stored and listed by event number and type. Time intervals between events are indicated between each event, Fig 12.2 shows event 16 is Local selected status.



Fig 12.1

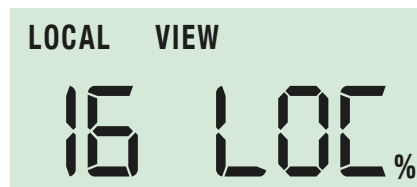

Fig 12.2

CMA FAULT HISTORY STRING DEFINITIONS

FAULT	STRING	DESCRIPTION
LOS Command	CMD	Loss of Command Signal – The input command signal exceeded the range configure by the LOS LO and LOS HI parameters.
LOS Feedback	FB	Loss of Feedback Position – An error has occurred in reading the feedback device.
Stall Opening	STO	The actuator has been commanded to move in the open direction and has not done so for longer than the time limit set in STL TO parameter.
Stall Closing	STC	The actuator has been commanded to move in the closed direction and has not done so for longer than the time limit set in STL TO parameter.
Over Thrust Opening	OTH	The actuator has exceeded the Thrust Limit while running in the open direction.
Over Thrust Closing	CTH	The actuator has exceeded the Thrust Limit while running in the closed direction.
Over Torque Opening	OTQ	The actuator has exceeded the Torque Limit while running in the open direction.
Over Torque Closing	CTQ	The actuator has exceeded the Torque Limit while running in the closed direction.
Over Temperature	OTP	The actuator's current internal temperature has exceeded the maximum limit.
Loss of Comms	COM	Communications between the actuator and its communications card has been lost for longer than the time specified in the COM TO parameter.
Local Control	LOC	The actuator was configured for LOCAL control.

12. Fault History Menu

FLTHST
Fault History Access

12.1 Fault History (cont'd)

CMA FAULT HISTORY STRING DEFINITIONS

FAULT	STRING	DESCRIPTION
At Close Limit	CLL	The actuator was at or below the CLOSE LIMIT setting.
At Open Limit	OPL	The actuator was at or above the OPEN LIMIT setting.
ESD Active	ESD	The Emergency Shut Down (ESD) feature was activated.
Dither	DIT	The unit has exceeded 2000 starts per hour where the change in position is greater than 1% of travel.
Relay One Energized	R1	Relay one is energized.
Relay Two Energized	R2	Relay two is energized.
EEPROM Fault, params	EE	An error was found in the current parameter area of the EEPROM.
EEPROM Fault, customer	CEE	An error occurred when the customer defaults were stored. The actuator will still run but the customer defaults should be checked and reconfigured if necessary. Save any changes before cycling the power. Cycling the power will clear the fault, contact Rotork if the problem persists.
EEPROM Fault, factory	FEE	An error occurred when the Factory defaults were stored. The actuator will still run but the Factory defaults should be checked and resaved. Cycling the power will clear the fault, contact Rotork if the problem persists.
Reset	RST	The actuator was reset (power cycled).
Monitor Relay	MNR	The actuator was not available for proper remote operation (General or Critical Fault).
Local Control Knob Stop	LCS	The local control knob was set to the LOCAL STOP position.
Local Control Knob Remote	LCR	The local control knob was set to the REMOTE position.
Local Control Knob Local	LCL	The local control knob was set to the LOCAL STOP position.
Loss of Power	LOP	Loss of power occurred. Units with RPP only.
Charge Mode	CHG	Charge Mode initiated. Units with RPP only.

13. Default Menu

DEFLT5 Default Menu Access

13.1 Default Menus

Set the actuator to **LOCAL** control to access menu.

Use the Enter/Cancel pushbuttons to select Customer or Factory default options.

Select Edit mode and **ENTER** to load the selected defaults.



Fig 13.1



Fig 13.2

LD CUS

LD CUS - LOAD CUSTOMER DEFAULTS

Select **EDIT** mode and press **ENTER**.

The **CONFIRM** parameter is now displayed, press **ENTER** to return the actuator to the stored customer defaults.



Fig 13.3

ST CUS

ST CUS - SAVE CURRENT SETTINGS

Select **EDIT** mode and press **ENTER**.

The **CONFIRM** parameter is now displayed, press **ENTER** to save the current settings to the actuators customer default memory.



Fig 13.4

LD FAC

LD FAC - LOAD FACTORY DEFAULTS

Select **EDIT** mode and press **ENTER**.

The **CONFIRM** parameter is now displayed, press **ENTER** to restore factory defaults.



Fig 13.5

13. Default Menu

13.2 Parameter Default Values

13.2.1 Basic Menu

PARAMETER	DEFAULT VALUE
Position	No default setting is a read parameter
Setpoint	No default setting is a read parameter
Thrust or Torque	No default setting is a read parameter
Local/Remote	LOC - local
Manual Jog	No default setting is a control
Close Limit (zero)	Set to fully extended at factory
Open Limit (span)	Set to fully retracted at factory
CMD 4	Set at factory via a 4 mA input
CMD 20	Set at factory via a 20 mA input
Command Signal Invert	Set at factory to OFF
Transmitter Signal Invert	Set at factory to OFF
Deadband	1.0%
STATUS	No Default / status access
ADVANCED MENU	No Default / menu access
DEFAULTS	No Default / default access

13.2.2 Advanced Menu

PARAMETER	DEFAULT VALUE
CPT 4 (Current Pos tx cal)	Set at factory to output 4 ma
CPT 20 (Current Pos tx cal)	Set at factory to output 20 ma
SPEED	100%
TURNS*	No Default - Calculated from Close and Open limits
Open Direction*	No Default - Calculated from Close and Open limits
Stall Time out	2.0 Seconds
Knob Disable	Set at factory to OFF
FHSTCL	No default setting / history clear access
Command Source	Analog
INFORMATION ACCESS	No Default / menu access
CONTROL CFG ACC	No Default / menu access
RELAY ACC	No Default / menu access
SPLIT RANGE	No Default / menu access
ACTUATOR CONFIG	No Default / menu access

13.2.3 Information Menu

PARAMETER	DEFAULT VALUE
Actuator Starts	No default setting is a read parameter
Amplifier Starts	No default setting is a read parameter
Temperature	No default setting is a read parameter
Software Version	No default setting is a read parameter

* Only available on CMR Rotary actuators.

13. Default Menu

13.2.4 Control Configuration Menu

PARAMETER	DEFAULT VALUE
Control Algorithm	Open loop
Input Dampening	0 seconds
Input Signal Loss Time out	0 seconds
Input Signal Loss Action	Close
Input Signal Loss Position	50%
Input Signal Loss Low Level	3.6 mA
Input Signal Loss High Level	20.4 mA
TORQ O	100%
TORQ C	100%
CL ACT	LIM
OP ACT	LIM

13.2.5 Relays 1 & 2 Menu

PARAMETER	DEFAULT VALUE
Relay 1 Config	None
* Relay 1 Pos	25%
Relay 1 Form	Energize on Condition
Relay 2 Config	None
* Relay 2 Pos	75%
Relay 2 Form	Energize on Condition

* Only shown when configured as Drive to Position (won't be configured for position on default)

13.2.6 Split Range Menu

PARAMETER	DEFAULT VALUE
Lower Range Value	4 mA
Upper Range Value	20 mA
CMD Below Split Range Action	Disabled - no action
CMD Above Split Range Action	Disabled - no action

13.2.7 Actuator Config Menu

PARAMETER	DEFAULT VALUE
Actuator Type	Set at Factory to match actuator build
Actuator Size	Set at Factory to match actuator build
Encoder Initialization	Set at Factory at middle of travel

13.2.8 UPS Menu

PARAMETER	DEFAULT VALUE
Loss of Power Action	Disabled - No action
Loss of Power Position	50%
Loss of Power Time out	0 Seconds
Loss of Power Speed	100%
Override Remote Control	ON - Loss of power action overrides remote control
Override Local Control	OFF - Local control overrides loss of power action
Override Local Stop Control	OFF - Local Stop control overrides loss of power action

14. Advanced Menu

14.1 Advanced Menu Access

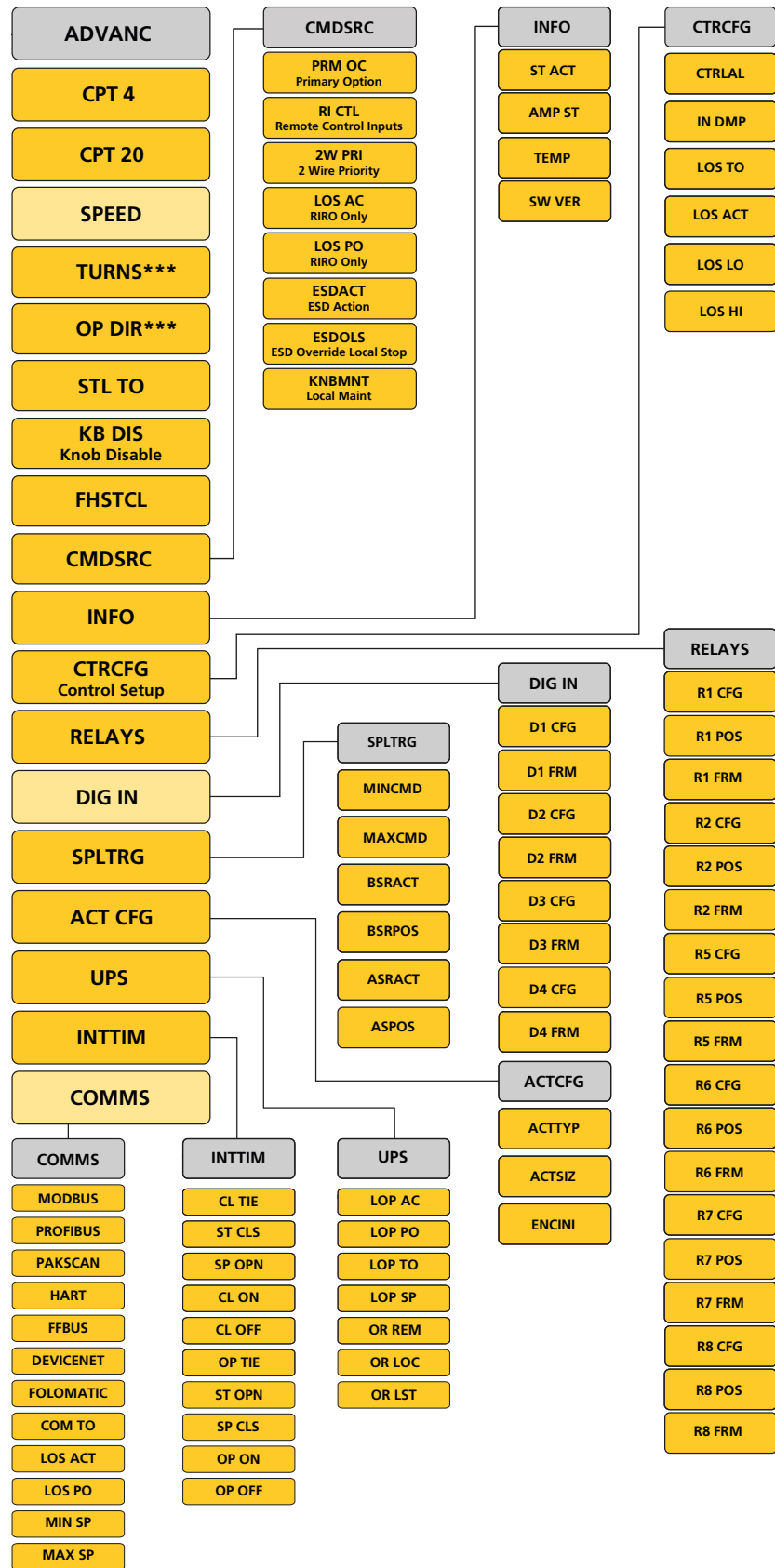

NOTE: Additional Relay, Digital Inputs and Comms menus shown are dependant on options fitted. Menus will not appear unless option is fitted.

*** Note these menus only apply to CMR units.

14. Advanced Menu

ADVANCED SETTINGS	ADVANC
CPT 4 - Current POS Transmitter - Zero/4 ma	CPT 4
CPT 20 - Current POS Transmitter - SPAN (20 mA)	CPT 20
SPEED - Adjust Actuator Output Speed	SPEED
URNS - CMR ONLY	URNS***
OP DIR - CMR ONLY	OP DIR***
STL TO - STALL TIME	STL TO
KB DIS - Knob Disable	KB DIS Knob Disable
FHSTCL - Fault History Clear	FHSTCL
CMDSRC - COMMAND SOURCE	CMDSRC
INFO	INFO
CTRCFG - CONTROL CONFIGURATION	CTRCFG Control Setup
RELAYS - RELAY CONFIGURATION	RELAYS
DIG INPUTS - Configure Digital Inputs (if fitted)	DIG IN
SPLTRG - SPLIT RANGE	SPLTRG
ACT CFG - ACTUATOR CONFIGURATION	ACT CFG
UPS - Configure settings for the Reserve Power Pack (if fitted)	UPS
INTTIM - Timer Interrupt	INTTIM
COMMS - Configure COMMS Option Cards (if fitted)	COMMS

ADVANC

14.2 Advanced Menu

Parameters can only be changed with actuator selected to Local Operation Mode.

Press UP/DOWN pushbuttons until ADVANC menu is displayed. Press Enter to gain access to the Advanced Menu parameters.

Use the UP/DOWN pushbuttons to scroll to the parameter you wish to modify. Press 'Enter' to go to Edit Mode.

Use the UP/DOWN pushbuttons to modify the parameter setting. Press Enter again to store selection. The display will confirm that your selection has been SAVED.

Press Cancel to return to previous menu.

CPT 4

14.2.1 CPT 4 Current Position Transmitter - Zero Adjustment

Connect a suitable meter. Enter Edit mode and use the UP/DOWN pushbuttons to adjust the 4 mA (ZERO) output.

CPT 20

14.2.2 CPT 20 Current Position Transmitter - Span Adjustment

Connect a suitable meter. Enter Edit mode and use the UP/DOWN pushbuttons to adjust the 20 mA (SPAN) output.

SPEED

14.2.3 SPEED - Adjust Actuator Output Speed

Actuator output speed is adjustable between 50% and 100% of its rated speed. Default is 100%.

CMR UNITS ONLY:

URNS - Set the number of full turns from the Close end of travel limit position. Always configure the Close limit prior to setting turns.

OP DIR - The operating direction is automatically determined during the basic setup process. Use this parameter to manually configure operating direction.

STL TO

14.2.4 STL TO - Stall Time

Motor stall time adjustable between 1 to 10 seconds. DEFAULT is 2 seconds.

KB DIS

14.2.5 KB DIS - Knob Disable

The local control knobs can be disabled using this setting. Setting OFF will maintain normal operation of the local control knobs. Setting ON will disable the local control knobs and prevent operating mode changes. Operating mode is set with the internal HMI. The external display will continue to provide position and status feedback.

FHSTCL

14.2.6 FHSTCL - Fault History Clear

Enter Edit mode. The CONFIRM parameter is now displayed, press Enter to clear the stored fault history.

14. Advanced Menu

CMDSRC

14.2.7 CMDSRC - Command Source

Select between Analogue, Digital or Bus Remote Commands.

PRM OC Primary Option Selection

Select the on board Analogue or Bus System option for primary remote control.

- PO - ANA** Standard Analogue Control
- PO - HRT** HART Option Control
- PO - PB** Profibus Option Control
- PO - MOD** Modbus Option Control
- PO - PAK** Pakscan Option Control
- PO - FFB** Foundation Fieldbus Control
- PO - DEV** DeviceNet Option Control
- PO - FOL** Folomatic Option Control

RI CTL Remote Input Control Selection

Select alternative options for remote control.

- RC - OFF** No Remote Control
- RC - DIO** Respond to configured Digital Command Inputs when DIO option card is fitted
- RC - POC** Respond to Primary Option control
- RC - PSH** Respond to switched control between Primary and Digital input commands. (Requires DIO option to be fitted and one of the inputs to be configured for Manual/Auto operation)

2W PRI Remote Control 2 Wire Priority

Select the actuator action when two conflicting remote control requests (Open & Close) are present.

- WP-SPT** Stayput or STOP
- WP-CLS** Run Closed
- WP-OPN** Run Open

LOS AC Actuators with RIRO Digital Input/Output Option only

Action on loss of internal communications.

- LA- DIS** Disabled
- LA- CLS** Run Closed
- LA- SPT** Stayput or Stop
- LA-OP** Run Open
- LA-POS** Go to position

LOS PO Set the Loss Of Internal Comms Failure Position when LA-POS selected

COMMAND SOURCE

Primary Option Selection

Remote Input Control Selection

Remote Control 2 Wire Priority

Actuators with RIRO Digital Input/Output Option

Loss of Internal Comms Failure Position

Emergency Shutdown Action

Emergency Shutdown Override Local Stop

Maintain Local Control

CMDSRC

PRM OC
Primary Option

RI CTL
Remote Control Inputs

2W PRI
2 Wire Priority

LOS AC
RIRO Only

LOS PO
RIRO Only

ESDACT
ESD Action

ESDOLS
ESD Override Local Stop

KNBMNT
Local Maint

ESDACT Emergency Shutdown Action

Select the actuator action when an ESD command is active via the COMMS Bus system or hardwired input.

- EA-DIS** Disabled
- EA-CLS** Run Closed
- EA-SPT** Stayput or STOP
- EA-OPN** Run Open

ESDOLS Emergency Shutdown Override Local Stop

Units with Local Controls only.

- EO - OFF** Local Stop overrides ESD Command
- EO - ON** ESD overrides all local control modes

KNBMNT Maintain Local Control

KM - OFF Local Open/Close selector is push to run. Unit only runs whilst the Open or Close selector knob is held in position.

KM - ON Local Open/Close selector is maintained. Unit only runs once the Open or Close selector knob is operated.

Select 'STOP' to cancel the movement.

14. Advanced Menu

INFORMATION

ST ACT - ACTUATOR STARTS

AMP ST - AMPLIFIER STARTS

TEMP - TEMPERATURE

SW VER - SOFTWARE VERSION

INFO

ST ACT

AMP ST

TEMP

SW VER

CTRCFG - Control Setup

CRTLAL - Control Algorithm

IN DMP - Input Damping

LOS TO - Loss of Signal Time Out

LOS ACT - Loss of Signal Action

LOS LO - Loss of Signal Low

LOS HI - Loss of Signal High

CTRCFG

CRTLAL

IN DMP

LOS TO

LOS ACT

LOS LO

LOS HI

INFO

14.2.8 INFO

Select between Actuator Starts, Amplifier Starts, Temperature and Software Version.

CTRCFG

14.2.9 CTRCFG - Control Setup

CTRLAL - Control Algorithm

Currently supports Open Loop control only.

IN DMP- Input Damping

Time period over which the command input signal is averaged.

Range is 0 to 10 seconds.

LOS TO - Loss of Signal Time Out

Loss of signal timeout can be set to between 0 to 5 seconds in 0.1 second increments.

Default is 0 seconds.

LOS ACT - Loss of Signal Action

Action on loss of command signal.

Selections are:

CLS - Close

OPN - Open

SPT - Stayput

POS - Run to Position

DIS - Disabled

LOS LO - Loss of Signal Low

The threshold of command signal below the level classed as 'LOST'. Adjustable between 3 to 4 mA. Default = 3.6 mA.

LOS HI - Loss of Signal High

The threshold of command signal above the level classed as Lost or out of range. Adjustable between 20 to 21 mA. Default = 20.4 mA.

14. Advanced Menu

RELAYS

14.2.10 RELAYS

There are two configurable relays mounted on the main PCB.

R1(2) CFG - RELAY 1(2) CONFIGURATION

The menu structure is the same for both relays. 1C or 2C denotes which relay menu is active.

DIO - DIGITAL INPUT AND RELAY OUTPUT OPTION PCB (If Fitted)

The DIO option pcb provides an additional 4 configurable Relays R5 to R8.

These relays have the same functions and method of Configuration as Relays R1 and R2.

Relay Indication functions are as follows:

NON	No Function
POS	Intermediate position indication. If selected then an additional POS menu is available. Go to R1(2) POS menu, select and save the position in travel at which the relay is to activate
GNF	General Fault
CMD	Loss of Command Signal
LFB	Loss of Feedback Signal
STO	Motor Stalled in Open Direction
STC	Motor Stalled in Closed Direction
OTQ(TH)	Open Torque/Thrust Overload
CTQ(TH)	Close Torque/Thrust Overload
OTP	Over Temperature
COM	Loss of Bus Communications
LOC	Local Selected
CLL	Closed Limit
OPL	Open Limit
ESD	Emergency Shutdown Active
CRF	Critical Fault
DIT	Dither Exceeding 2000 1% position changes per hour
MNR	Monitor Relay Active (Available)
LOP	Loss of Power
CHG	Charge Mode
DIG	Energised by Bus Command

RELAYS

R1 CFG - Relay 1 Config

R1 POS - Relay 1 Pos

R1 FRM - Relay 1 Form

R2 CFG - Relay 2 Config

R2 POS - Relay 2 Pos

R2 FRM - Relay 2 Form

R5 CFG - Relay 5 Config

R5 POS - Relay 5 Pos

R5 FRM - Relay 5 Form

R6 CFG - Relay 6 Config

R6 POS - Relay 6 Pos

R6 FRM - Relay 6 Form

R7 CFG - Relay 7 Config

R7 POS - Relay 7 Pos

R7 FRM - Relay 7 Form

R8 CFG - Relay 8 Config

R8 POS - Relay 8 Pos

R8 FRM - Relay 8 Form

Namur 107

7MN Maintenance Alarm

7OS Out of specification Alarm

7FC Function check Alarm

7FL Failure Alarm

R1(2) POS Select Position Here

R1(2) FRM Relay Form

EOC Energise on Condition Active
(Normally Open Contact)

DOC De-energise on Condition Active
(Normally Closed Contact)

RELAYS

R1 CFG

R1 POS

R1 FRM

R2 CFG

R2 POS

R2 FRM

R5 CFG

R5 POS

R5 FRM

R6 CFG

R6 POS

R6 FRM

R7 CFG

R7 POS

R7 FRM

R8 CFG

R8 POS

R8 FRM

14. Advanced Menu

DIGITAL INPUT

D1 CFG - Digital 1 Config

D1 FRM - Digital 1 Form

D2 CFG - Digital 2 Config

D2 FRM - Digital 2 Form

D3 CFG - Digital 3 Config

D3 FRM - Digital 3 Form

D4 CFG - Digital 4 Config

D4 FRM - Digital 4 Form



14.2.11 DIGITAL INPUT

DIO - Digital Input and Relay Output option PCB (if fitted)

The DIO Option PCB provides 4 off Digital Contact Inputs D1 to D4 that can be configured for hard wired remote control.

For example:

D1 CFG	Configuration
D1-NON	Disabled
D1-OPN	Open Command Input
D1-CLS	Close Command Input
D1-MAIN	Stop/Maintain Command Input
D1-ESD	ESD Command Input
D1-PSH	Primary switched Input Switch between Primary and Hardwired Control
D1-FRM	Contact Form
D1-NO	Normally Open contact
D1-NC	Normally Closed contact



14.2.12 SPLTRG - Split Range Operation

MINCMD - Minimum Split Range Command Select value of 4 to 20 mA input to correspond to minimum (Zero) position.

MAXCMD - Maximum Split Range Command Select value of 4 to 20 mA input to correspond to maximum (Span) position.

BSRACT - Below Split Range Action Action when command signal falls below the minimum split range set value.

Options are as follows:

DIS - Disabled

CLS - Close

OPN - Open

SPT - Stayput

POS - Go to Position

BSRPOS - Set Go to Position when command falls below the minimum split range set value.

ASRACT - Above Split Range Action Action when command signal rises above the maximum split range set value.

Options are as follows:

DIS - Disabled

CLS - Close

OPN - Open

SPT - Stayput

POS - Go to Position

ASPOS - Set Go to Position when command rises above the maximum split range set value.

SPLIT RANGE OPERATION

MINCMD - Minimum Split Range Command

MAXCMD - Maximum Split Range Command

BSRACT - Below Split Range Action

BSRPOS - Set Go to Position

ASRACT - Above Split Range Action

ASPOS - Set Go To Position

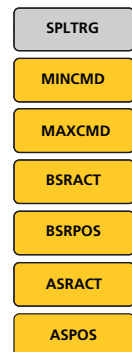

14. Advanced Menu

ACTCFG - ACTUATOR CONFIGURATION

ACTCFG

ACTTYP - ACTUATOR TYPE

ACTTYP

ACTSIZ - ACTUATOR SIZE

ACTSIZ

ENCINI - ENCODER INITIALIZATION

ENCINI

ACTCFG

14.2.13 ACTCFG - Actuator Configuration

ACTTYP - Actuator Type

AT QT - Quarter-turn Unit

AT ROT - Rotary Unit

AT LIN - Linear Unit

This setting must match the configuration of the unit to ensure correct operation.

ACTSIZ - Actuator Size

This parameter matches the Torque or Thrust characteristic of the actuator model. For example CMQ-500 lbf.in.

This setting must match the configuration of the unit to ensure correct operation.

CAUTION

ENCINI - Encoder Initiation

This procedure is only necessary after replacement of electronics assemblies or disassembly of the actuator drive system. The Encoder **MUST** be re-initialised before electrical operation.

This procedure will invalidate the current travel limit settings. The travel limits MUST be reset before putting the actuator back in to service.

Select the ENCINI menu and enter the Edit mode.

Use the UP or DOWN pushbuttons to move the actuator to the centre position of travel.

Press ENTER to Re-Initialise the Encoder.

The travel Limits must now be Reset and any characterisation parameters re-installed.

UPS

14.2.14 UPS - Reserve Power Pack Configuration

The Reserve Power pack consists of an super capacitor pack that can be configured to carry out an action on the loss of power.

LOP AC - Loss of Power Action

Action to be taken on Power Loss:

OPN - Run to the configured OPEN limit

SPT - Stayput, remain at current position

CLS - Run to the configured CLOSE limit

POS - Run to configured position (See LOP PO)

DIS - Action disabled

LOP PO - Loss of Power Position

When LOC AC is set to POS the actuator will run to its configured loss of power position. Can be set between 0 to 100% of travel.

LOP TO - Loss of Power Timeout

On loss of power the LOC AC action can be delayed. Timeout can be set between 0 to 5 seconds.

LOP SP - Loss of Power Speed

The speed at which the actuator will travel when executing the LOC AC operation. Can be set between 50 to 100% of its Rated speed.

OR REM - Override Remote Control Mode

OFF - Actuator will respond to the command inputs when selected for remote operation and the RPP is active.

ON - The LOP AC action will override the Remote command inputs.

OR LOC - Override Local Control Mode

OFF - Local open and close operation enabled whilst RPP is active.

ON - The LOP AC action will override Local operation.

OR LST - Override Local Stop mode

OFF - Local Stop mode has priority over all control modes.

ON - The LOP AC action will override Local stop mode.

RESERVE POWER PACK CONFIGURATION

UPS

LOC AC - Loss of Power Action

LOP AC

LOP PO - Loss of Power Position

LOP PO

LOP TO - Loss of Power Timeout

LOP TO

LOP SP - Loss of Power Speed

LOP SP

OR REM - Override Remote Control Mode

OR REM

OR LOC - Override Local Control Mode

OR LOC

OR LST - Override Local Stop Mode

OR LST

14. Advanced Menu

INTTIM

14.2.15 INTTIM - Timer Interrupt

The timer interrupt function enables pulsed "stop/start" operation by the actuator as a response to local and remote control commands. This effectively increases the valve stroke time and can be adjusted to prevent hydraulic shock (water hammer) and flow surges in pipelines.

CL TIE - Closed-end Timer Interrupt Enable

OFF - Closed end Timer Interrupt is disabled.
ON - Closed end Timer Interrupt is enabled.

ST CLS - Start Close, start position for closed end timer interrupt - Position below which the closed end timer interrupt is active when closing. Can be set from 0 to 100% position. Must be set below SP CLS (Stop Close).

SP OPN - Stop Open, stop position for closed end timer interrupt - Position above which the closed end timer interrupt is inactive when opening. Can be set from 0 to 100% position. Must be set below ST OPN (Start Open).

CL ON - Close ON Time

The actuator run (ON) time around the closed end of travel, when the closed end timer interrupt is enabled and active. Can be set from 1 to 99 seconds.

CL OFF - Close OFF Time

The actuator Inhibit (OFF) time around the closed end of travel, when the close end timer interrupt is enabled and active. Can be set from 1 to 99 seconds.

OP TIE - Open end Timer Interrupt Enable

OFF - Opened end Timer Interrupt disabled.
ON - Opened end Timer Interrupt enabled.

ST OPN - Start Open, start position for opened end timer interrupt - Position above which the opened end timer interrupt is active when opening. Can be set from 0 to 100% position. Must be set above SP OPN (Stop Open).

TIMER INTERRUPT

CL TIE - Closed-end Timer Interrupt Enable

ST CLS - Start Close

SP OPN - Stop Open

CL ON - Close ON Time

CL OFF - Close OFF Time

OP TIE - Open end Timer Interrupt Enable

ST OPN - Start Open

SP CLS - Stop Close

OP ON - Open ON Time

OP OFF - Open OFF Time

INTTIM

CL TIE

ST CLS

SP OPN

CL ON

CL OFF

OP TIE

ST OPN

SP CLS

OP ON

OP OFF

SP CLS - Stop Close, stop position for opened end timer interrupt - Position below which the opened end timer interrupt is inactive when closing. Can be set from 0 to 100% position. Must be set above ST CLS (Start Close).

OP ON - Open ON Time

The actuator run (ON) time around the opened end of travel, when the opened end timer interrupt is enabled and active. Can be set from 1 to 99 seconds.

OP OFF - Open OFF Time

The actuator Inhibit (OFF) time around the opened end of travel, when the opened end timer interrupt is enabled and active. Can be set from 1 to 99 seconds.



Blue denotes the active area for the closed end timer interrupt, when enabled.

Yellow denotes the active area for the opened end timer interrupt, when enabled.

14. Advanced Menu

COMMS

14.2.16 COMMS - Bus Option Card Configuration

The following menus appear automatically when a Bus Option Card is fitted.

For full details of each Bus Option Card and its menu settings please refer to the relevant technical manual.

MODBUS

MODBD	Modbus BaudRate
MODFT	Modbus Field Type
MODAD	Modbus Address
MODPR	Modbus Parity
MODTM	Modbus Termination
MOD2A	Modbus Second Address

PROFIBUS

PROFT	Profibus Field Type
PROAD	Profibus Address
PRORT	Profibus Redundancy Type
PRORM	Profibus Redundancy Mode
PROT1	Profibus Termination1
PROT2	Profibus Termination2
GSDAC	Profibus GSD Active Characterisation Active

PAKSCAN

PAKAD	Pakscan Address
PAKBD	Pakscan Baud Rate

HART

HRTAD	Hart Address
HRTDS	Hart Demand Source

FOUNDATION FIELDBUS

FFB FT	Foundation Fieldbus Type
--------	--------------------------

DEVICENET

DEVAD	DeviceNet Address
DEVBD	DeviceNet Baud Rate

COMMS

MOD BD
MOD FT
MOD AD
MOD PR
MOD TM
MOD 2A
PRO FT
PRO AD
PRO RP
PRO RM
PRO T1
PRO T2
GSD AC
PAK AD
PAK BD
HRT AD
HRT DS
FFB FT
DEV AD
DEV BD
F RANG
FCAL L
FCAL H
COM TO
LOS ACT
LOS POS
MIN SP
MAX SP

FOLOMATIC

F RANGE	Select mA or voltage (5 V or 10 V) type signal
FCAL L	Calibrate Low signal setpoint Apply low input analogue signal and save setting
FCAL H	Calibrate High signal setpoint Apply High input analogue signal and save setting

To apply changes the actuator must be set to "LOCAL" operation and in "EDIT" mode.

Save to confirm changes.

STANDARD PARAMETERS (ALL BUS CARDS)

COMTO	Comms Time Out
LOSACT	Loss of Comms Action
LOSPOS	Loss of Comms Position
MINSP	Minimum Span
MAXSP	Maximum Span

15. Power Ratings

Listed below are the nominal current ratings for the CMA:

CML-100/250, CMQ-250/500, CMR-50/100/200

Current rating at nominal line voltages (A)										
Ambient	Type	Power (W)	24 VDC	110 VAC	115 VAC	120 VAC	208 VAC	220 VAC	230 VAC	240 VAC
20 °C	CML	16.36	0.68	0.21	0.20	0.19	0.11	0.11	0.10	0.10
	CMQ	26.90	1.12	0.35	0.33	0.32	0.18	0.17	0.17	0.16
	CMR	23.14	0.96	0.30	0.29	0.28	0.16	0.15	0.14	0.14
-20 °C	CML	27.82	1.16	0.37	0.35	0.37	0.20	0.19	0.18	0.17
	CMQ	40.39	1.69	0.53	0.51	0.49	0.28	0.27	0.26	0.25
	CMR	31.46	1.32	0.41	0.40	0.38	0.22	0.21	0.20	0.19
-30 °C	CML	36.50	1.52	0.47	0.45	0.43	0.25	0.24	0.23	0.22
	CMQ	52.60	2.19	0.68	0.65	0.63	0.36	0.34	0.33	0.31
	CMR	34.50	1.44	0.45	0.43	0.41	0.24	0.22	0.21	0.21
-40 °C	CML	44.50	1.85	0.58	0.55	0.53	0.31	0.29	0.28	0.26
	CMQ	59.50	2.48	0.77	0.74	0.71	0.41	0.39	0.37	0.35
	CMR	37.50	1.56	0.49	0.47	0.45	0.26	0.24	0.23	0.22

CML-750, CMQ-1000, CMR-89/125/250

Current rating at nominal line voltages (A)										
Ambient	Type	Power (W)	24 VDC	110 VAC	115 VAC	120 VAC	208 VAC	220 VAC	230 VAC	240 VAC
20 °C	CML	51.46	2.14	0.67	0.64	0.61	0.35	0.33	0.32	0.31
	CMQ	41.46	1.73	0.54	0.52	0.49	0.28	0.27	0.26	0.25
	CMR	59.50	2.48	0.77	0.74	0.71	0.41	0.39	0.37	0.35
-20 °C	CML	59.50	2.48	0.77	0.74	0.71	0.41	0.39	0.37	0.35
	CMQ	59.50	2.48	0.77	0.74	0.71	0.41	0.39	0.37	0.35
	CMR	59.50	2.48	0.77	0.74	0.71	0.41	0.39	0.37	0.35
-30 °C	CML	59.50	2.48	0.77	0.74	0.71	0.41	0.39	0.37	0.35
	CMQ	59.50	2.48	0.77	0.74	0.71	0.41	0.39	0.37	0.35
	CMR	59.50	2.48	0.77	0.74	0.71	0.41	0.39	0.37	0.35
-40 °C	CML	59.50	2.48	0.77	0.74	0.71	0.41	0.39	0.37	0.35
	CMQ	59.50	2.48	0.77	0.74	0.71	0.41	0.39	0.37	0.35
	CMR	59.50	2.48	0.77	0.74	0.71	0.41	0.39	0.37	0.35

16. Rotork Sales and Service

If your Rotork actuator has been correctly installed and sealed, it will give years of trouble-free service.

Should you require technical assistance or spares, Rotork guarantees the best service in the world. Contact your local Rotork representative or the factory direct at the address on the nameplate, quoting the actuator type and serial number.

Local representative:

Non-Hazardous and Hazardous Certified Enclosures

All CMA actuator hazardous and non-hazardous area enclosures are watertight to IP66, IP67 and NEMA 4.

CMA actuators are available with the following enclosure types for which the ambient working temperature ranges are stated.

The limits of frequency of operation are a function of the load on the actuator and the ambient temperature.

Under the heaviest load at the highest temperature the capability would be not less than 2,000 starts in one hour, in favorable load conditions the number of starts per hour would be infinite.

Option temperatures use different actuator components, please specify temperature requirement. Hazardous area approvals for other country standards are available; please contact Rotork.

CMA range actuators are built in accordance with the following standards:

Non-Hazardous Area Enclosures

WT: Standard Watertight

Standard	Rating	Standard Temperature	Low Temperature Option
BS EN 60529 (1992)	IP67	-30 to +70 °C (-22 to +158 °F)	-40 to +60 °C (-40 to +140 °F)
NEMA (US)	4 & 6	-30 to +70 °C (-22 to +158 °F)	-40 to +60 °C (-40 to +140 °F)
CSA (Canadian)	4 & 6	-30 to +70 °C (-22 to +158 °F)	-40 to +60 °C (-40 to +140 °F)

Hazardous Area Enclosures

European ATEX Directive: CE 2809

Directive/Standard	Rating	Standard Temperature	Low Temperature Option
Directive = 2014/34/EU	II 2GD	-20 to +65 °C (-4 to +150 °F)	
Standard = EN 60079-0 EN 60079-1, EN 60079-31 EN 80079-36, EN 80079-37	Ex db h IIB T4 Gb Ex h tb IIIC T85°C Db	Units fitted with UPS or HMI Option -20 to +60 °C (-4 to +140 °F)	-40 to +60 °C (-40 to +140 °F)

UKEK Directive: UKCA 1725

Directive/Standard	Rating	Standard Temperature	Low Temperature Option
Directive = 2014/34/EU and SI 2016 NO. 1107	II 2GD	-20 to +65 °C (-4 to +150 °F)	
Standard = EN IEC 60079-0:2018, EN 60079-1:2014, EN 60079-31:2014, EN ISO 80079-36:2016, EN ISO 80079-37:2016	Ex db IIB T4 Gb Ex tb IIIC T85°C Db	Units fitted with UPS or HMI Option -20 to +60 °C (-4 to +140 °F)	-40 to +60 °C (-40 to +140 °F)

International Hazardous Area IECEx

Directive/Standard	Rating	Standard Temperature	Low Temperature Option
Directive = 2014/34/EU		-20 to +65 °C (-4 to +150 °F)	
Standard = IEC 60079-0 IEC 60079-1 IEC 60079-31	Ex db IIB T4 Gb Ex tb IIIC T85°C Db	Units fitted with UPS or HMI Option -20 to +60 °C (-4 to +140 °F)	-40 to +60 °C (-40 to +140 °F)

USA Hazardous Area – Factory Mutual (FM) Certified Explosionproof to NEC Article 500

Class	Division	Group	Standard Temperature	Low Temperature Option
I	1	C, D	-20 to +65 °C (-4 to +150 °F)	-40 to +60 °C (-40 to +140 °F)
II	1	E, F, G	Units fitted with UPS or HMI option -20 to +60 °C (-4 to +140 °F)	

Enclosure types 4, IP66/67/68

Canadian Hazardous Area – Factory Mutual Canada (FMC) Certified Explosionproof to Canadian Electrical Code (CEC)

Class	Division	Group	Standard Temperature	Low Temperature Option
I	1	C, D	-20 to +60 °C (-4 to +140 °F)	-40 to +60 °C (-40 to +140 °F)
II	1	E, F, G	Units fitted with UPS or HMI option -20 to +60 °C (-4 to +140 °F)	

Enclosure types 4, IP66/67/68

Note: Reliability in respect to fatigue or long-term operation against CSA C22.2 No. 139 standard is not included in the Approval.

China Hazardous Area – China Certification Corporation (CCC) Certified Explosionproof to CNCA-C23-01:2019 and CNEX-C2301-2019

Directive/Standard	Rating	Standard Temperature	Low Temperature Option
No directive		-20 to +65 °C (-4 to +150 °F)	-40 to +60 °C (-40 to +140 °F)
CNCA-C23-01:2019	Ex db IIB T4 Gb	Units fitted with UPS or HMI Option	
CNEX-C2301-2019	Ex tb IIIC T85°C Db	-20 to +60 °C (-4 to +140 °F)	

This product has obtained CCC certification and meets the requirements of GB/T3836.1-2021 and GD/T3836.2-2021

Specific Conditions of Use

The parameters of the flameproof joint surface are inconsistent with the value given in Article 5.1 of GB3836.2-2010, please contact the manufacturer for the specific flameproof joint surface size information.

⚠ WARNING

The device has a non-metallic coating with potential electrostatic hazards. Clean only with a damp cloth.

Do not open when there is explosive gas.

The bolts that hold the external window frame are an important part of ensuring the integrity of the flameproof enclosure and must not be removed.

End users should choose cable entry devices that have obtained CCC certification, explosion-proof marks not less than Ex d IIB Gb and protection levels not less than actuator protection levels, and install them in accordance with their instructions.

Environmental Conditions

- a) Altitude up to 5000 meters
- b) CMA adheres to requirements consistent with Overvoltage Category II
- c) The CMA adheres to the requirements consistent with a Pollution Degree of 2

Special Conditions For Safe Use (ATEX, IECEx, UKCA and CSA approved actuators)

1. In accordance with clause 5.1 of IEC/EN 60079-1, the critical dimensions of the flamepaths are:

CML-100/250

Flamepath	Maximum Gap (mm)	Minimum Width L (mm)
Lid/base	0.15	12.8
Base/screw shaft	0.145 ¹	13.5
Base/feedback shaft bush	-0.02 ²	13.7
Feedback shaft bush/feedback shaft	0.06	13.7
Handknob shaft/lid (short cover)	0.10	25.9
Handknob shaft/lid (intermediate and extended covers)	0.10	15.7

CMR-50/100/200

Flamepath	Maximum Gap (mm)	Minimum Width L (mm)
Lid/base	0.15	12.8
Base/pinion shaft	0.235 ¹	29.8
Base/output shaft	0.145 ¹	12.8
Handknob shaft/lid (short cover)	0.10	25.9
Handknob shaft/lid (intermediate and extended covers)	0.10	15.7

CMQ-250/500

Flamepath	Maximum Gap (mm)	Minimum Width L (mm)
Lid/base	0.15	12.8
Base/pinion shaft	0.235 ¹	29.8
Base/feedback shaft bush	-0.02 ²	13.7
Feedback shaft bush/feedback shaft	0.06	13.7
Handknob shaft/lid (short cover)	0.10	25.9
Handknob shaft/lid (intermediate and extended covers)	0.10	15.7

CML-750

Flamepath	Maximum Gap (mm)	Minimum Width L (mm)
Lid/base	0.15	12.8
Base/pinion shaft	0.235 ¹	37.3
Base/feedback shaft bush	-0.02 ²	13.7
Feedback shaft bush/feedback shaft	0.06	13.7
Handknob shaft/lid (short cover)	0.10	25.9
Handknob shaft/lid (intermediate and extended covers)	0.10	15.7

CMR-89/125/250

Flamepath	Maximum Gap (mm)	Minimum Width L (mm)
Lid/base	0.15	12.8
Base/pinion shaft	0.235 ¹	37.3
Base/output shaft	0.145 ¹	13.0
Handknob shaft/lid (short cover)	0.10	25.9
Handknob shaft/lid (intermediate and extended covers)	0.10	15.7

CMQ-1000

Flamepath	Maximum Gap (mm)	Minimum Width L (mm)
Lid/base	0.15	12.8
Base/pinion shaft	0.235 ¹	37.3
Base/feedback shaft bush	-0.02 ²	13.7
Feedback shaft bush/feedback shaft	0.06	13.7
Handknob shaft/lid (short cover)	0.10	25.9
Handknob shaft/lid (intermediate and extended covers)	0.10	15.7

Note 1: This dimension includes an allowance for the 0.05mm requirements defined in clause 8.1.2 of IEC 60079-1:2014. **Note 2:** Negative Sign denotes an interference fit.

- The equipment utilises a non-metallic outer coating and has a potential static hazard. Clean only with a damp cloth.
- The screws securing the outer window frame maintain the integrity of the flameproof enclosure and must not be removed.

Certification Numbers

Europe (ATEX)	FM17ATEX0011X / FM17ATEX0012X
Great Britain (UKCA)	FM21UKEX0071X / FM21UKEX0072X
International (IECEx)	IECEx FMG 17.006X / IECEx FMG 17.007X
United States (US)	FM17US0101
Canada (FMC)	FM18CA0156X
China (CCC)	2021312307000246 / 2021312307000247 / 2021312307000248

rotork®

www.rotork.com

A full listing of our worldwide sales and service network is available on our website.

Rotork plc
Brassmill Lane, Bath, UK
tel +44 (0)1225 733200
email mail@rotork.com

USA
Rotork Controls
tel +1 (414) 461 9200
email rpcinfo@rotork.com



PUB094-009-00

PUB094-009-00
Issue 05/23

Original instructions: English language version only. As part of a process of on-going product development, Rotork reserves the right to amend and change specifications without prior notice. Published data may be subject to change. For the very latest version release, visit our website at www.rotork.com
The name Rotork is a registered trademark. Rotork recognises all registered trademarks. Published and produced in the UK by Rotork. POLTG0523