



rotork[®]

Keeping the World Flowing
for Future Generations

IQT Range Installation and Maintenance Instructions

⚠ This manual contains important safety information. Please ensure it is thoroughly read and understood before installing, operating or maintaining the equipment.

PUB002-004-00
Date of issue 08/13



The Rotork Setting Tool allows actuator control, indication and protection functions to be configured to suit site requirements. In addition, the new Setting Tool *Pro* also allows downloading of datalogger and uploading/downloading of configuration files. Files are transferred to and from the Setting Tool *Pro* via Rotork Insight.

It is essential that all the actuator settings are checked for compatibility with the valve, process and control system requirements before the actuator is put into service. Please read this publication.

When Rotork personnel or nominated agents are contracted to carry out site commissioning and/or acceptance, documentation of commissioned actuator configuration can be made available for customer records.



Rotork Setting Tool Pro



Rotork Setting Tool

This manual covers IQT range actuators:

- * IQT - Operation of isolating/regulating 1/4 turn valves.
- * IQTM - Operation of modulating 1/4 turn valves.
- * IQTF - Operation of part-turn and slow speed multi-turn valves.
- * IQTFS - Battery failsafe.

It provides instruction on:

- * Manual and electrical (local and remote) operation.
- * Preparation and installation of the actuator onto the valve.
- * Commissioning and adjustment of the Primary Settings for correct valve operation.
- * Commissioning and adjustment of the Secondary Settings to suit site-specific control and indication requirements.
- * Maintenance – Troubleshooting.
- * Sales and Service.

Refer to Publication E185E for repair, overhaul and spare part instructions.

THE ROTORK IQT RANGE – THE FIRST 1/4 TURN VALVE ACTUATOR THAT YOU CAN COMMISSION AND INTERROGATE WITHOUT REMOVING ELECTRICAL COVERS.

Using the supplied infra-red Setting Tool to access the actuator set up procedures, “point and shoot” setting of torque levels, position limits and all other control and indication functions can be made safely, quickly and conveniently, even in hazardous locations. The IQT allows commissioning and adjustment to be carried out with the main power supply to the actuator switched on or off.

Standard diagnostics access information about the control system, valve and actuator status in the form of display icons and help screens.

Instantaneous valve torque and position can be monitored on the actuator with a single key press of the Setting Tool.

The on board Datalogger captures operational and valve torque data enabling informed maintenance choices to be made. IQ Insight software for PC allows the Datalogger to be interrogated, as well as the complete actuator set up to be configured and recorded.

The actuator containing the Setting Tool will be identified with a yellow label on the terminal cover.

Visit our web site at www.rotork.com for more information on the IQT and other Rotork actuator ranges.

Identifying Actuator Parts

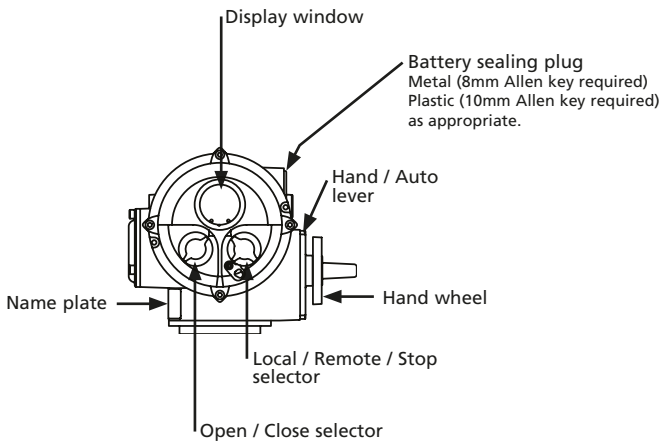
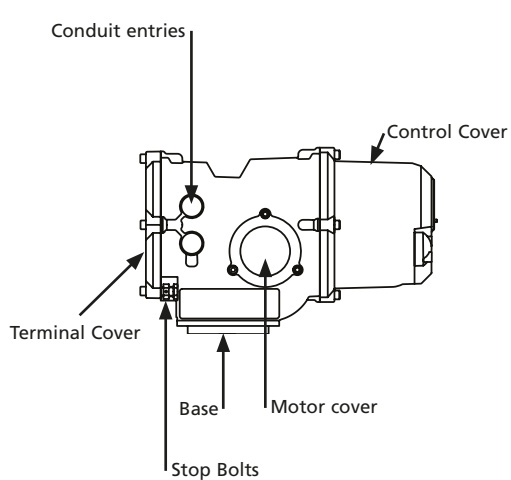

	Page		Page		Page
1 Health and Safety	2	6 Cable Connections	10	10 IQT Battery Failsafe Instructions	62
2 Storage	3	6.1 Earth/Ground Connections	10	10.1 Introduction	62
3 Operating your IQT Actuator	3	6.2 Removing Terminal Cover	10	10.2 Specification	63
3.1 Operating by Hand	3	6.3 Cable Entry	10	10.1 Commissioning instructions	64
3.2 Operating Electrically	3	6.4 Connecting to Terminals	10	11 Maintenance, Monitoring and Troubleshooting	67
3.3 Display – Local Indication	4	6.5 Replacing Terminal Cover	10	11 Torque-reference profile	69
3.4 Display Status Indication – Travel	5	7 Commissioning	11	11.1 Setting Tool <i>Pro</i> Download & Upload	70
3.5 Display Status Indication – Control	5	7.1 The Setting Procedure	11	11.2 Help Screens	73
3.6 Display Alarm Indication	5	7.2 The Rotork Setting Tools	12	11.3 IQT Infrared Diagnostic & Configuration	78
4 Preparing Drive Bush	7	7.3 Entering the Actuator Setting Procedure	15	11.4 Environmental	79
4.1 Bases F05 to F07 and FA05 to FA07	7	7.4 Setting Mode – Password	15	12 Weights and Measures	80
4.2 Bases F10 to F14 and FA10 to FA14	7	7.5 New Password	15	Binary, Hexadecimal and Decimal Conversion Table	81
4.3 Machining the Drive Bush	7	7.6 Checking Mode	15	13 IQT Approvals	82
4.4 Fitting the Drive Bush	7	7.7 Crossroad	16	Approved Fuses	83
5 Mounting the Actuator	8	7.8 The Actuator Display – Setting/Checking Mode	16	Maximum Flamepath Gaps	83
5.1 IQT Actuators	8	7.9 Returning to Valve Position Display	16	Appendix A	84
5.2 IQTM Actuators	8	8 Commissioning – Basic Settings	17		
5.3 IQTF Actuators	8	Basic Settings Contents	18		
5.4 Lifting the Actuator	8	9 Commissioning – Configuration Settings	27		
5.5 Securing Actuator to Valve	8	Configuration Settings Contents	29		
5.6 Stop Bolts	9	Default Options	60		

Health and Safety

This manual is produced to enable a competent user to install, operate, adjust and inspect Rotork IQT range valve actuators. Only persons competent by virtue of their training or experience should install, maintain and repair Rotork actuators. Work undertaken must be carried out in accordance with the instructions in this and any other relevant manuals. The user and those persons working on this equipment should be familiar with their responsibilities under any statutory provisions relating to the Health and Safety of their workplace. Due consideration of additional hazards should be taken when using the IQT range of actuators with other equipment. Should further information and guidance relating to the safe use of the Rotork IQT range of actuators be required, it will be provided on request.

The electrical installation, maintenance and use of these actuators should be carried out in accordance with the National Legislation and Statutory Provisions relating to the safe use of this equipment, applicable to the site of installation.

For the UK: Electricity at Work Regulations 1989 and the guidance

given in the applicable edition of the "IEE Wiring Regulations" should be applied. Also the user should be fully aware of his duties under the Health and Safety Act 1974.

For the USA: NFPA70, National Electrical Code® is applicable.

The mechanical installation should be carried out as outlined in this manual and also in accordance with relevant standards such as British Standard Codes of Practice. If the actuator has nameplates indicating that it is suitable for installation in hazardous areas then the actuator may be installed in Zone 1, Zone 21, Zone 2 and Zone 22 (or Div 1 or Div 2, class I or Class II) classified hazardous area locations only. It should not be installed in hazardous area locations with an ignition temperature less than 135°C, unless suitability for lower ignition temperatures has been indicated on the actuator nameplate. It should only be installed in hazardous area locations compatible with the gas groups stated on the nameplate.

The electrical installation, maintenance and the use of the actuator should be carried out in accordance with the code of practice relevant for that particular Hazardous Area certification.

No inspection or repair should be undertaken unless it conforms to the specific hazardous area certification requirements. Under no circumstances should any modification or alteration be carried out on the actuator as this could invalidate the actuators hazardous area approval certification. Access to live electrical conductors is forbidden in the hazardous area unless this is done under a special permit to work, otherwise all power should be isolated and the actuator moved to a non-hazardous area for repair or attention.

WARNING: Thermostat Bypass

If the actuator is configured to bypass the motor thermostat then the hazardous area certification will be invalidated. Additional electrical hazards may occur when using this configuration. The user should ensure that any necessary additional safety measures are considered.

WARNING: Enclosure Materials

IQT actuators are manufactured from aluminium alloy with stainless steel.

The user must ensure that the operating environment and any materials surrounding the actuator cannot lead to a reduction in the safe use of, or the protection afforded by, the actuator.

Where appropriate the user must ensure the actuator is suitably protected against its operating environment.

WARNING: Operating by Hand

With respect to handwheel operation of Rotork electric actuators, see warning on p3.

 **This actuator must only be located in areas where the risk of impact to the viewing window is low.**

 **Actuator may start and operate when remote control is selected, depending on remote control signal status and actuator configuration.**

2 Storage

If your actuator cannot be installed immediately store it in a dry place until you are ready to connect incoming cables.

If the actuator has to be installed but cannot be cabled it is recommended that the plastic transit cable entry plugs are replaced with metal plugs which are sealed with PTFE tape.

The Rotork double-sealed construction will preserve internal electrical components perfectly if left undisturbed.

It is not necessary to remove any electrical compartment covers in order to commission the IQT actuator.

Rotork cannot accept responsibility for deterioration caused on-site once the covers are removed.

Every Rotork actuator has been fully tested before leaving the factory to give years of trouble free operation, providing it is correctly commissioned, installed and sealed.

3 Operating your IQT Actuator

3.1 Operating by Hand

WARNING

With respect to handwheel operation of Rotork electric actuators, under no circumstances should any additional lever device such as a wheel-key or wrench be applied to the handwheel in order to develop more force when closing or opening the valve as this may cause damage to the valve and/or actuator or may cause the valve to become stuck in the seated/backseated position.



Fig. 3

To engage handwheel drive, turn the Hand/Auto lever clockwise whilst turning the handwheel, see Fig 3. The lever can now be released upon which it will return to its original position. The handwheel will remain engaged until the actuator is operated electrically when it will automatically disengage and return to motor drive. If required the Hand/Auto lever can be locked in either position using a padlock with a 6.5mm hasp.

3.2 Operating Electrically

Check that power supply voltage agrees with that stamped on the actuator nameplate. Switch on power supply. It is not necessary to check phase rotation.

 **Do not operate the actuator electrically without first checking, using the infra-red Setting Tool, that at least the Primary Settings have been made (refer to Section 8 page 17).**

Selecting Local/Stop/Remote Operation

The red selector enables either Local or Remote control, lockable in each position using a padlock with a 6.5mm hasp.

When the selector is locked in the Local or Remote positions the Stop facility is still available. The selector can also be locked in the Stop position to prevent electrical operation by Local or Remote control.



Fig. 3.1

Local Control

With the red selector positioned at Local (anti-clockwise) the adjacent black knob can be turned to select Open or Close. To Stop, turn red knob clockwise.

Remote Control

Rotate the red selector to the Remote position (clockwise), this gives remote control only for Open and Close but local Stop can still be used by turning the red knob anti-clockwise.

3.3 Display–Local Indication



Fig. 3.2 The Actuator Display

The display consists of:

1. Position Display - This is the main 7-segment position display with icons.
2. Text Display - This is a 2 line, 16 characters dot matrix display which allows text to be used to complement the position display and icons.
3. Infra Red LED's.
4. 1 x Bi colour LED, 1 x Amber colour LED for position indication.
5. Alarm Icon - This will be displayed for Valve, Control, and Actuator alarms. Alarm indication is supported by fault

description text in the lower display.

6. Battery Alarm Icon - This icon will be displayed when a battery is detected as low or flat. "Battery low" or "flat" will also be displayed in the lower display.

7. IR Icon - This icon flashes during infra red communication activity.

8. Percentage Open Icon - This icon will be displayed when a percentage Open value is in the upper display.

The liquid crystal display screen has 2 modes of position indication:

1. Valve position – power on
2. Valve position – power off

On power up the actuator's liquid crystal display screen is back-lit with an amber light and one of the indicator lamps will be on, dependent on position. The display screen will show percentage open or an end of travel symbol. (See Figs 3.3, 3.4 and 3.5)

As standard, red lamp signifies valve open, amber intermediate, and green lamp signifies valve closed. Open and closed colour functions can be reversed on request.

Open

The two tri-colour LED's will be Red, the open symbol and "Open Limit" will be displayed

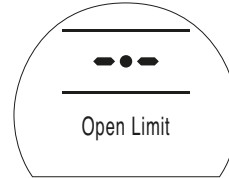

Fig. 3.3

Mid Travel

The two tri-colour LED's will be Amber, percentage open value will be shown and "Stopped" will be displayed when there is no actuator movement.



Fig. 3.4

Closed

The two tri-colour LED's will be Green, closed symbol and "Closed Limit" will be displayed.

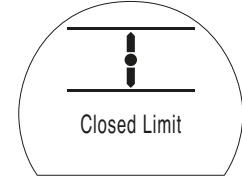

Fig. 3.5

With the main power supply switched off, the display screen is powered by a battery and continues to display actuator position. However, the battery does not support screen back-lighting, position indicator lamps or dot matrix display.

LED Indicators

⚠ WARNING: Mid Travel LED colour may be affected by viewing angle and lighting level.

The Close LED colour can be changed to red if required. The Mid Travel amber LED can be switched off if required. Refer to Section 9.16, page 58.

3.4 Display Status Indication – Travel

The IQT display provides real time status indication. The top line of the text display is reserved for travel status indication. Fig 3.6 shows the travel status example **Closed Limit**.

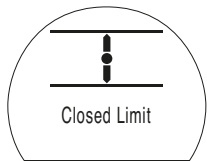

Fig. 3.6

Available travel status conditions displayed:

- **Closed Limit** Actuator has reached the set closed limit position.
- **Open Limit** Actuator has reached the set open limit position.
- **Moving Open** Actuator is traveling in the open direction.
- **Moving Closed** Actuator is traveling in the closed direction.
- **Stopped** Actuator has stopped in a mid travel position, indicated in the top display (%open).

- **Timer Active** Interrupter Timer option enabled only. Interrupter Timer has stopped the actuator mid travel for a period equal to the set Timer Off time. *Refer to 9.13 page 55.*

3.5 Display Status Indication – Control

The bottom line of the text display is reserved for control status indication and is displayed for approximately 2 seconds after the control mode or signal is applied. Fig 3.7 shows the control status example **Remote Control**.

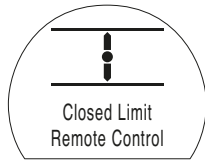

Fig. 3.7

Available control status conditions displayed:

- **Local Control** Local control selected - red selector.
- **Local Stop** Local stop selected – red selector.

- **Remote Control** Remote control selected – red selector.
 - **Local Close** Local close signal applied – black selector.
 - **Local Open** Local open signal applied – black selector.
 - **Remote Close** Remote close (hardwired or analogue) signal applied.
 - **Remote Open** Remote open (hardwired or analogue) signal applied.
 - **Remote ESD** Remote hardwired emergency shut down signal applied.
 - **Remote Bus Open** Remote Bus * open signal applied.
 - **Remote Bus Close** Remote Bus* signal applied.
 - **Remote Bus ESD** Remote Bus* emergency shut down signal applied.
- * *Bus Control option fitted may be Pakscan, Profibus, Modbus, DeviceNet or Foundation Fieldbus. Refer to actuator wiring diagram.*

3.6 Display Alarm Indication

The IQT display provides alarm indication in the form of text and alarm icons.

There are 2 alarm icons:

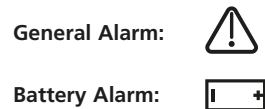

⚠ General Alarm

The general alarm icon will be supported with text in the bottom line indicating the particular alarm, or if more than one is present, each alarm will be displayed in sequence.

Fig 3.8 shows the status example **TORQUE TRIP CL**.



Fig. 3.8

Available alarm conditions displayed:

Valve Alarms

- **TORQUE TRIP CL** tripped off on torque while moving in the close direction.
- **TORQUE TRIP OP** tripped off on torque while moving in the open direction.
- **MOTOR STALLED** no movement detected after a signal to move.

Control Alarms

- **ESD ACTIVE** ESD signal applied. When present the ESD signal overrides all local and remote control signals. Once the ESD action is carried out operation is inhibited while the ESD signal is maintained. Refer to 9.3 ESD Action page 32.
- **INTERLOCK ACTIVE** Open and/or close interlocks are configured on and are active. Refer to 9.3 Interlock page 34. Operation in the direction of an active interlock(s) is inhibited. Note that when conditional control is configured, an active interlock will not inhibit local control operation.

Actuator Alarms

- **THERMOSTAT TRIP** Motor control thermostat has tripped due to extended motor operation. Operation is inhibited until the thermostat resets automatically when the motor control cools. Check actuator duty cycle against process requirements (running time, torque, ambient temperature).
- **PHASE LOST** (3-phase models only). The phase supply the actuator connected to terminal 3 is lost. Operation is inhibited.
- **24V LOST** The 24 volt customer supply (terminals 4 & 5) has tripped. Check remote control wiring. Supply is protected with a resettable fuse.
- **LOCAL CONTROL FAIL** Check operation of control selectors (black and red).
- **CONFIG ERROR** There may be an error in the configuration (set up) of the actuator. Check and reset basic setting and check configuration settings.
- **POS SENSOR FAIL** Detected failure in the position sensing system – contact Rotork.

- **TORQ SENSOR FAIL** Detected failure in the torque sensing system – contact Rotork.
- **EEPROM MISSING** Contact Rotork

Battery Alarm

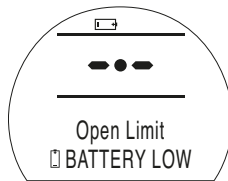



Fig. 3.7

The actuator checks the battery level at approximately 1 hour intervals. The battery alarm icon is displayed when the actuator detects its battery as being low and the display will indicate **BATTERY LOW**.

If the battery is flat or missing the display will indicate **BATTERY FLAT**.

 **When a low or flat battery alarm is displayed the battery should be replaced immediately. It is essential that the correct battery type is fitted to maintain actuator certification. Refer to page 67.**

 **After replacing a battery the alarm icon will continue to be displayed until the next check and may take up to 1 hour. Cycling the power will force a battery check and clear the alarm.**

PWR LOSS INHIBIT

If, on power up, the actuator detects a discharged battery and actuator power loss inhibit feature **[OS]** is enabled (refer to page 57), both battery and general alarm icons will be displayed and the bottom line will indicate alternately **PWR LOSS INHIBIT** and **BATTERY FLAT**. Electrical operation will be inhibited. The battery must be replaced and the limits must be reset. Refer to Section 11, page 67 and Section 8, page 17.

4.1 Bases F05 to F07 and FA05 to FA07

The base adaptor must be removed to give access to the drive bush. Remove the four capscrews and base adaptor as shown in figure 4.

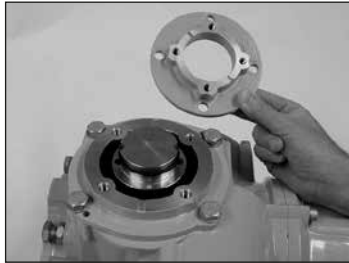

Fig. 4

Clear access to the drive bush is now available as shown in figure 4. Using the a 3mm allen key, unscrew the two capscrews retaining the drive bush and remove the drive bush from the actuator.

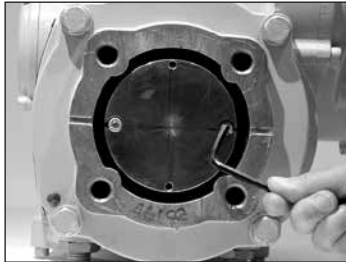

Fig. 4.1

4.2 Bases F10 to F14 and FA10 to FA14

Removal of the drive bush does not require the removal of the actuator base. Using a 3mm allen key, unscrew the two capscrews retaining the drive bush.

Capscrews can be used to remove the drive bush by screwing into the drive bush as shown in figure 4.2.

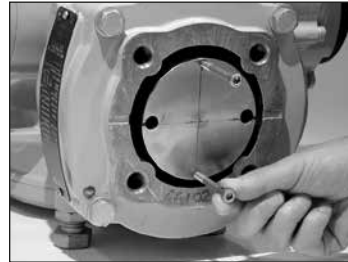

Fig. 4.2

The range of IQT drive bushes is shown in figure 4.3. Please refer to PUB002-001 for maximum stem acceptance details.



Fig. 4.3

4.3 Machining the Drive Bush

Once removed, the drive bush can be machined to suit the valve stem. Ensure machined position allows correct orientation of actuator-to valve flange and correct direction to close the valve.

4.4 Fitting the Drive Bush

Note: The drive bush can be fitted in four possible positions, 90° apart. Fit the drive bush into the centre column ensuring that the stem orientation, actuator position and direction of operation are correct for valve operation. Secure the drive bush with the capscrews. For F05, FA05, F07 and FA07 bases, refit the base adaptor and secure with the four capscrews.

5.1 IQT Actuators

The IQT range of actuators are suitable for part turn applications requiring up to 60 starts per hour.

5.2 IQTM Actuators

The IQTM range of actuators are suitable for modulating control duty of up to 1200 starts per hour in accordance with IEC 34-1 to S4 50%. Commissioning of IQTM range actuators is identical to the standard IQT (refer to Sections 7, 8 and 9).

5.3 IQTF Actuators

The IQTF range of actuators are suitable for part-turn and multi-turn, non-thrust applications requiring low speed and low operating turns. Commissioning of IQTF range actuators is similar to the standard IQT (refer to Sections 7, 8 and 9).

5.4 Lifting the Actuator

(Refer to Weights and Measures page 80 for actuator weight.)

Ensure the valve is secure before fitting the actuator, as the combination may be top heavy and therefore unstable.

If it is necessary to lift the actuator using mechanical lifting equipment certified slings should be attached as indicated in Figure 5. At all times trained and experienced personnel should ensure safe lifting, particularly when mounting actuators.

⚠ WARNING:
Do not lift the actuator by the handwheel.

A suitable mounting flange conforming to ISO 5210 or USA Standard MSS SP101 must be fitted to the valve. Actuator to valve fixing must conform to; Material Specification ISO Class 8.8, yield strength 628 N/sq mm.

⚠ WARNING:
Do not lift the actuator and valve combination via the actuator. Always lift the valve/actuator assembly via the valve.

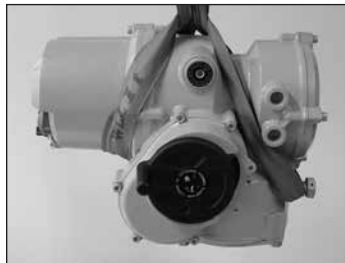

Fig. 5

⚠ WARNING:
The actuator should be fully supported until full valve stem engagement is achieved and the actuator is secured to the valve flange.

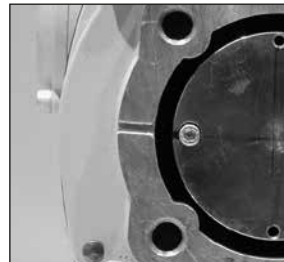

Fig. 5.1

5.5 Securing Actuator to Valve

Before engagement ensure that the actuator and valve are in the same position (i.e. closed) and the drive bush-machining matches the stem position. Actuator position can be determined using the display (refer to section 3.3 page 4) and if necessary can be moved using the handwheel (refer to section 3.1 page 3). It may be necessary to adjust the stop bolts to enable sufficient travel. Refer to section 5.6 page 9.

Secure actuator to valve with four fixing bolts. Check that the cast groove in actuator base is not obstructed see Fig 5.1. Its purpose is to protect the actuator in the event of a product leak from the valve stem/gland packing. Check base fixing bolts are tight.

5.6 Stop Bolts

It is recommended that stop bolt adjustment be carried out by the valvemaker/supplier before the valve is fitted into pipework. Once installed, the valve maker/supplier should be consulted before stop bolt re-adjustment is carried out. Stop bolts can be wired to prevent tampering. After setting or adjustment of stop bolts the actuator limits must be reset, refer to Limits LC, LO page 24.

The IQT stop bolts are located below the terminal compartment. Stop bolt adjustment allows $\pm 5^\circ$ variation of travel at each end position. Screwing bolts in reduces movement, out increases movement. For clockwise closing valves the right hand bolt is the closed stop as shown with spanner in fig 5.2. The left is the open stop. Stop bolts are factory set to give a nominal 90° travel.



Fig. 5.2

Stop Bolt sizes.

IQT 125 to 500: M12 bolt requiring 19mm AF spanner.

IQT1000 & 2000: M20 bolt requiring 30mm AF spanner.

Adjustment for non seating valves types

For closed and open stop position adjustment:

Undo stop bolt lock-nut. Move actuator and valve to the required stopping position (it may be necessary to unscrew stop bolt to allow more travel). Screw stop bolt in until a stop is felt. Tighten stop bolt lock nut.

Adjustment for seating valves types

For closed and open stop position adjustment:

Undo stop bolt lock-nut. Move actuator and valve to the required seating position of the valve (it may be necessary to unscrew stop bolt to allow more travel). Screw stop bolt in until a stop is felt and then back off by 3 turns. Tighten stop bolt lock-nut.

Reset actuator limits

Refer to Limits LC, LO page 24.

⚠ WARNING:
Ensure all power supplies are isolated before removing actuator covers.

Check that the supply voltage agrees with that stamped on actuator nameplate.

A switch or circuit breaker must be included in the wiring installation of the actuator. The switch or circuit breaker shall be mounted as close to the actuator as possible and shall be marked to indicate that it is the disconnecting device for that particular actuator. The actuator must be protected with overcurrent protection devices rated in accordance with Rotork publication No. E135E Electric motor performance data for IQT range actuators.

⚠ WARNING:
Actuators for use on phase to phase voltages greater than 600V A.C. must not be used on supply systems such as floating, or earth-phase systems, where phase to earth voltages in excess of 600V A.C. could exist.

6.1 Earth/Ground Connections

A lug with a 6mm diameter hole is cast adjacent to the conduit entries for attachment of an external protective earthing strap by a nut and bolt. An internal earth terminal is also provided, however it must not be used alone as the protective Earth Connection.

6.2 Removing Terminal Cover

Using a 6mm Allen key loosen the four captive screws evenly. Do not attempt to lever off the cover with a screwdriver as this will damage the "O" ring seal and may damage the flamepath on a certified unit.

Actuators containing a Setting Tool fitted to the inside of the terminal compartment cover are identified with a self-adhesive yellow label on the outside of the terminal compartment cover.

The wiring code card fixed in the cover is particular to each actuator and must not be interchanged with any other actuator. If in doubt check the serial number on the code card with that of the actuator.

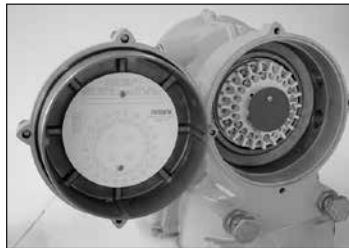

Fig. 6

A plastic bag in the terminal compartment contains: Terminal screws and washers, spare cover "O" ring seal, wiring diagram and instruction book.

6.3 Cable Entry

Only appropriate certified Explosion-Proof entry reducers, glands or conduit may be used in hazardous locations.

Remove red plastic transit plugs. Make cable entries appropriate to the cable type and size. Ensure that threaded adaptors, cable glands or conduit are tight and fully waterproof. Seal unused cable entries with a steel or brass threaded plug. In hazardous areas an appropriately certified threaded blanking plug must be used.

The cable entries on the actuator terminal housing are tapped M25 x 1.5p.

6.4 Connecting to Terminals

On EExde enclosure units connections to the power and control terminals must be made using AMP type 160292 ring tabs for power and earth terminals and AMP type 34148 ring tabs for the control terminals.

Refer to the wiring diagram inside the terminal cover to identify functions of terminals. Check that supply voltage is the same as that marked on the actuator nameplate.

Remove power terminal screen.

Begin by connecting these cables and replace screen.

When all connections are made ensure wiring diagram is replaced in the terminal compartment.

6.5 Replacing Terminal Cover

Ensure cover "O" ring seal and spigot joint are in good condition and lightly greased before re-fitting cover.

7

Commissioning

7.1 The Setting Procedure

The Rotork IQT range of actuators is the first that enables commissioning to be carried out without removing covers.

Setting torque, limit and other functions is achieved by using the Infra-Red Setting Tool. The Setting Tool is certified Intrinsically Safe to allow commissioning in hazardous areas.

All the commissioning functions are stored in non-volatile memory in the actuator. The Setting Tool enables the user to view all the functions in turn via the actuator display window. As each function is viewed its setting can be checked and, if required, changed within the bounds of that function.

Commissioning may be carried out with main power switched on or off. Refer to page 17 for Power Off Setting.

The setting procedure is divided into two stages:

1. Basic Settings

Settings for end of travel limit actions, torque values, limit positions etc.

2. Configuration Settings

Settings covering the control, indication and optional equipment functions.

NOTE: For IQT Battery Failsafe instructions, see Section 10 page 62.

**WARNING:**

All IQT actuator functions are configured before dispatch to Rotork standard default settings unless alternatives have been specified with the order. Should difficulty be encountered during commissioning the default settings can be reinstated, returning the actuator configuration to its original manufactured state. Site commissioning can then begin again (refer to Section 9.18 page 59).

The default function should be used with caution as settings selected after manufacture may be essential for the safe operation of the valve and/or plant.

Actuator Display

Position Display

50

This may be an open or closed symbol or a percentage open value.

Torque and Position

50

Refer to Section 11.

Password

P?

PC

Ir

tP

Crossroad

cr

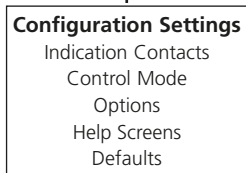
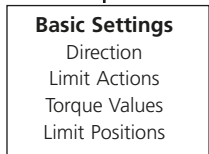





Note: The Basic Settings must be commissioned first.

7.2 The Setting Tool (old version)



Specification

Enclosure	IP67
Certification	EEx ia IIC T4 (intrinsically safe) FM, INT SAFE, Class I & II Div 1 Groups A B C D E F G, T4A CSA, Exia, Class I, II Div 1 Groups A B C D
Power supply	9V Battery (supplied and fitted)
Operating range	0.75m (from actuator display window)

Name Instruction

1.  Key* Display next function down
 2.  Key* Display next function across
 3.  Key Decrease/change displayed function's value or option setting
 4.  Key Increase/change displayed function's value or option setting
 5.  Key Enter displayed value or option setting
- * Pressing the two arrow keys together returns the actuator display to the position indication mode

Infra-red local operation (when enabled)

5.  Key Stop actuator
6.  Key Open actuator
7.  Key Close actuator
8. Infra-red Transmitter Window

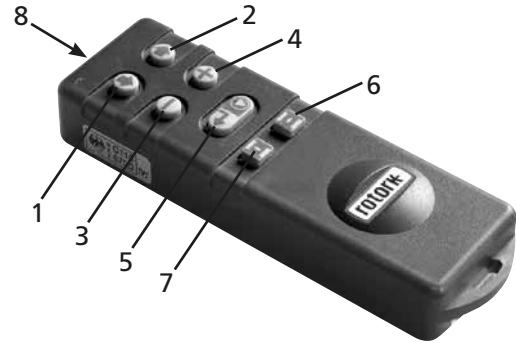



Fig. 7.1 The Setting Tool

Setting Tool Battery Replacement

Battery status can be checked by looking at the Infra-red transmitter window while depressing any Setting Tool button. A flashing red indicator should be seen.

 **Battery replacement must be carried out in a safe area. To replace the battery remove the six caphead screws in the back of the Setting Tool. Remove the back cover to expose the battery.**

 **In order to maintain hazardous area certification fit only Duracell MN1604 or Rayovac Alkaline Maximum NoAL-9V battery types. Refit cover ensuring red indicator LED faces the transmitter window in the back cover.**

When a button is depressed the Setting Tool transmits the relevant instruction to the actuator by infra-red pulses and must therefore be directly in front of the actuator indicator window and at a distance no greater than 0.75m.

7.2 The Setting Tool Pro (new version)

Specification

Enclosure IP54

This Setting Tool *Pro* has been built in accordance with the following standards:

USA - Hazardous Area.

Factory Mutual - Explosion Proof to NEC Article 500.

Intrinsically Safe, Class 1, Div 1, Groups A, B, C & D, T4.

Canada - Hazardous Area.

CSA - Exia Intrinsically Safe, Class 1, Div 1, Groups A, B, C & D, T4.

Temperature Tamb = -30°C to 50°C

Power supply 2x 1.5V Batteries (supplied and fitted)

Operating range 0.75m (from actuator display window)

Name Instruction

- | | |
|-----------|--|
| 1. ↓ Key* | Display next function down |
| 2. ↑ Key | Display previous function up |
| 3. → Key* | Display next function across |
| 4. ← Key | Display previous function across |
| 5. - Key | Decrease/change displayed function's value or option setting |
| 6. + Key | Increase/change displayed function's value or option setting |
| 7. ↓ Key | Initiate download/upload mode |
| 8. ↵ Key | Enter displayed value or option setting |

* Pressing these two arrow keys together returns the actuator display to the position indication mode

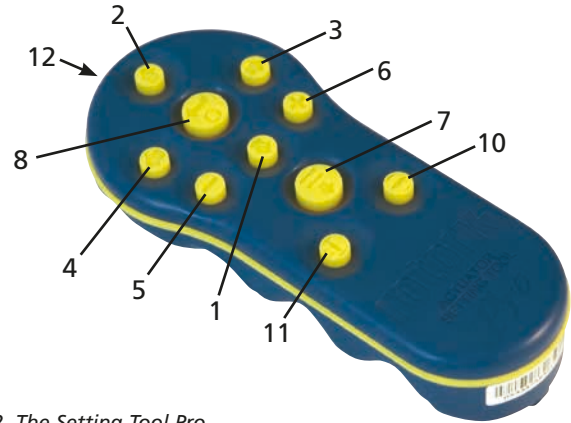

Fig. 7.2 The Setting Tool Pro

Infra-red local operation (when enabled)

- | | |
|----------------------------------|----------------|
| 9. ⏹ Key | Stop actuator |
| 10. ☰ Key | Open actuator |
| 11. ☷ Key | Close actuator |
| 12. Infra-red Transmitter Window | |

Download / Upload Function

This new feature has been introduced with the new Rotork Setting Tool *Pro*. It allows the user to download datalogger files and download/upload configuration files. The new tool is weatherproof and intrinsically safe and so it can be used safely in all environments. For more information refer to Section 11.1, page 70.

Setting Tool *Pro* Battery Replacement

Battery status can be checked by looking at the Infra-red transmitter window while depressing any Setting Tool *Pro* button except the download button. A flashing red indicator should be seen.

⚠ Battery replacement must be carried out in a safe area. To replace the battery remove the six cap head screws in the back of the Setting Tool *Pro*. Remove the back cover to expose the battery.

⚠ In order to maintain hazardous area certification the actuator Setting Tool *Pro* shall only be fitted with the following AA size, alkaline-manganese, approved battery types:

**Duracell, Coppertop, type MN1500
Duracell, Procell, type MN1500
GP, Super Alkaline, type GP15A**

Other types of AA size batteries, including Duracell, Ultra, type MN1500, must not be fitted. For battery replacement see Section 7.

Refit cover ensuring red indicator LED faces the transmitter window in the back cover.

The enclosure of the actuator Setting Tool *Pro* is manufactured from the materials:

**Polycarbonate, ABS blend
Polycarbonate
Silicon Rubber**

If the actuator Setting Tool *Pro* is likely to come into contact with aggressive substances (e.g. solvents that may affect polymeric materials), then it is the responsibility of the user to take suitable precautions (e.g. regular checks as part of the routine inspections or establishing that the materials are resistant to the specific chemical) that prevent it from being adversely affected, thus ensuring that the type of protection is not too compromised.

No form of repair must be attempted on the actuator Setting Tool *Pro*.

When a button is depressed the Setting Tool *Pro* transmits the relevant instruction to the actuator by infra-red pulses and must therefore be directly in front of the actuator indicator window and at a distance no greater than 0.75m.

Display Set-Up Mode

The Setting Tool and Setting Tool *Pro* arrow keys are used to access and navigate through the actuator set-up procedure using the actuator display. Each actuator function with its current setting is represented on screen by a combination of code and text. The Setting Tool change keys (+ and -) allow the user to view the available setting options.

The examples of displayed functions **Close Action, [C2]** and **Open Torque, [tO]** are shown to the right. Note that a setting option or value is highlighted.

This instruction manual uses both code and text for description.

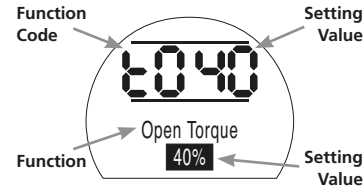

7.3 Entering the Actuator Setting Procedure

With the actuator securely mounted on the valve, the mains supply on and Local control or Stop selected.

PRESS THE ↓ KEY.

The actuator upper display will remain the same and the lower display will change to Torque value. This will be represented by Torque = XX% and a bar graph. (For instantaneous torque & position monitoring, refer to Section 11, page 68.)

PRESS THE ↓ KEY.

The actuator display will change and the password protection display will be seen.



The Actuator Function Settings can be protected by the Use of a Password

7.4 Setting Mode – Password

To enable setting and adjustment of the actuator functions the correct password must be entered. The factory set (default) password is [Id]. If the actuator has previously been set with a site password this must be entered.

Use the + or – keys to scroll through the available passwords 00–FF (hexadecimal). With the correct password displayed press the enter key.

PRESS THE ↵ KEY.

Two “setting” bars will appear and will remain visible on every function display screen. In addition, “Password Correct” will be displayed for 3 seconds.



Default Password, Setting Mode Enabled

7.5 New Password [PC]

To configure a new password, the actuator must be in setting mode with the password display – setting mode enabled – showing,

PRESS THE → KEY.

The display will change to [PC]. Using the + or – key scroll through the available passwords until the desired password is displayed.

PRESS THE ↵ KEY.



Password Changed to [IE]

NOTE: The new password becomes effective the next time setting mode is entered.

7.6 Checking Mode

The actuator function settings can be checked without entering the correct password. The settings can only be viewed and not altered. The setting bars will not be seen.



Password Display, Checking Mode

Once the procedure has been completed in the required mode

PRESS THE ↓ KEY.

The procedure branch [Cr] (crossroad) display can now be seen (refer to Section 7.7 page 16).

7.7 Crossroad [Cr]



To access the Basic Settings **press the arrow ↓ key** (refer to Section 8 Commissioning Basic Settings page 17).

To access the Configuration Settings **press the arrow → key** (refer to Section 9 Commissioning Configuration Settings page 27).

7.8 The Actuator Display – Setting/Checking Mode

Actuator functions as laid out in the Basic and Configuration commissioning stages, can be individually displayed by using the Setting Tool arrow keys.

The ↓ arrow key will always display the FIRST function on the next level DOWN within the procedure.

The → arrow key will always display the NEXT function on the SAME level and will wrap around the functions on the same level.

The actuator display indicator lamps will continue to indicate valve position but will also flash during IR communication.

Actuator functions are displayed in code form in the top left portion of the liquid crystal display screen.

The setting for the displayed function is shown in the top right hand portion of the screen. Depending on the actuator function displayed, its setting may be an option or a value.

Text relating to the function and setting values will be displayed in the lower display.

In setting mode the Setting Tool + or – keys will cause the setting to be changed. In checking mode the settings cannot be altered.

In setting mode, once displayed, a new setting can be entered into the actuator memory by **pressing the ↵ key**. The setting will flash off and back on, confirming its selection, and "Stored" will be displayed for 2 seconds in the text display.

TOP LEFT PORTION

Function e.g.
tC = Torque Close

TOP RIGHT PORTION

Function Setting
e.g. Value = 40%

LOWER DISPLAY

Function: Close Torque
Setting Value: 40%

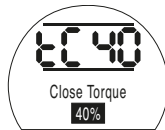

*Typical Actuator Function Display
Setting Mode Enabled*

7.9 Returning to Valve Position Display

There are five ways of returning to valve position display:

1. Approximately 5 minutes after the last Setting Tool operation the display will automatically return to position display.
2. Press the ↓ and → arrow keys together.
3. Press the ↓ arrow key until the display returns to position.
4. Select Remote control using the red Local/Stop/Remote selector.
5. If you have the new Setting Tool Pro then you can use the ↑ arrow key to return to position display.



ELECTRICAL OPERATION MUST NOT TAKE PLACE UNTIL THE BASIC SETTINGS HAVE BEEN MADE AND CHECKED.

The actuator's Basic Settings affect the correct operation of the valve by the actuator. If the actuator has been supplied with the valve, the valve maker or supplier may have already made these settings.

This instruction assumes setting mode has been entered (refer to section 7.4 page 15).

Viewing the Basic Settings

With the actuator mounted on the valve, the power supply on and Local or Stop control selected, point the Setting Tool at the actuator indicator window from a distance of no more than 0.75m. By pressing the ↓ key and, when appropriate, the → key, it is possible to move through the procedure, displaying the various functions and their settings as shown in Fig. 8.1 (refer to page 18). The right-hand side of Fig.8.1 explains the function of each LCD display.

Power Off Setting

IQT allows settings to be viewed and set without main power. To enable this function, engage handwheel drive and rotate until the output drive moves (refer to page 3). The Setting Tool can now be used. As long as a Setting Tool key press takes place within the 30 seconds timeout period, Power Off Setting will remain enabled. If no infra-red Setting Tool communication takes place the display will return to indicating position. The actuator must then be operated by handwheel to re-enable Power Off Setting.



Settings and operation must be verified by electric operation and function test of the actuator to ensure correct operation.

Viewing the Basic Settings

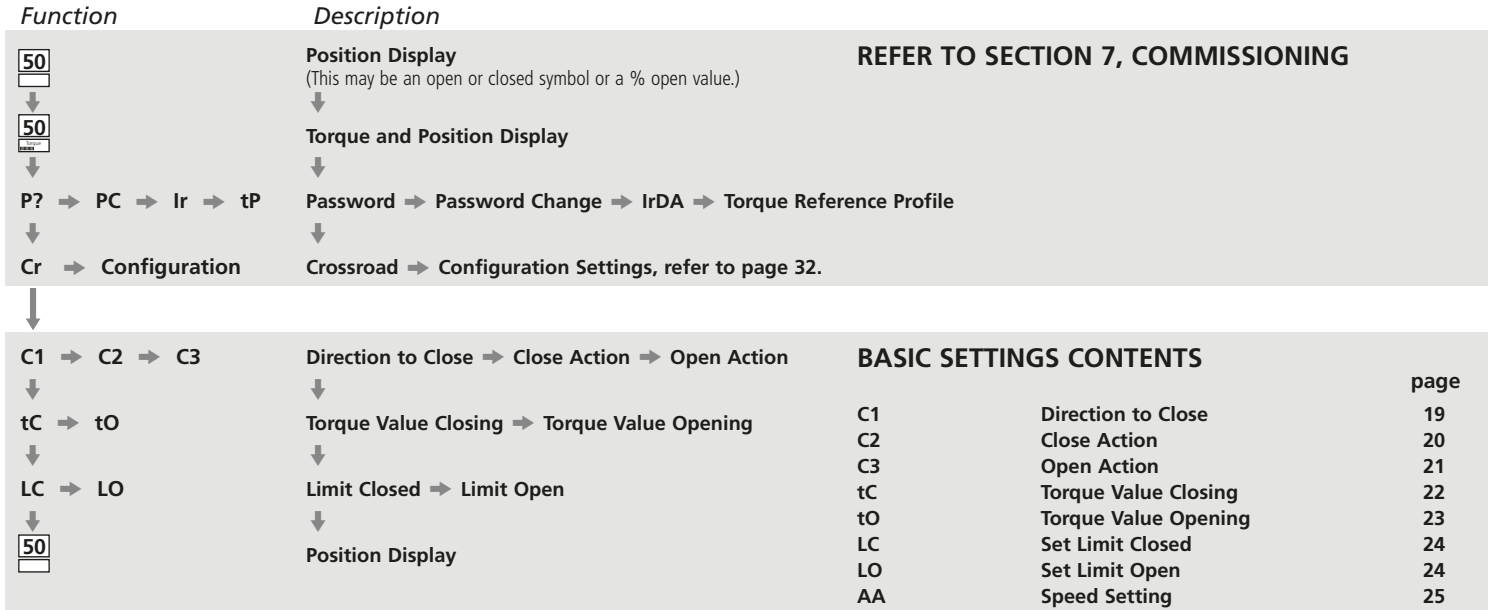

Fig. 8.1 Basic Setting Displays

C1 Direction to Close

The actuator can be configured to be clockwise or anti-clockwise to close. Manually operate actuator and valve to establish correct closing direction. Conversion Handwheel direction labels are available.

Using the + or - key, display the character conforming to correct closing direction.

Having ensured that the display corresponds to the established closing direction

PRESS THE ← KEY.

The displayed option will flash (stored), indicating that it has been set.

PRESS THE → KEY.

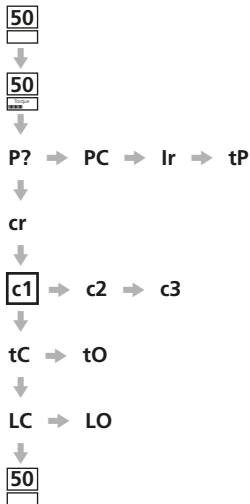

[C] in the Setting Field Indicating Clockwise to Close



[A] in the Setting Field Indicating Anti-clockwise to Close

C2

Close Action

IQT actuators are designed to stop at the end of travel by torque limitation against the actuator stop bolts. Stop bolts should therefore be set to the precise stopping position required, refer to section 5.6.

IQTF actuators can be configured to close on torque or limit. Refer to valve manufacturers instructions.

 **Refer to valve manufacturer for recommended setting.**

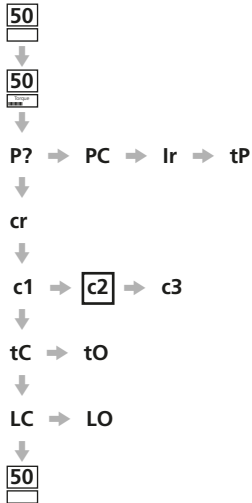

Using the + or – key, display the required option.



[Ct] in the Setting Field Indicating Close on Torque - default setting.



[CL] in the Setting Field Indicating Close on Limit.

Having selected the required option

PRESS THE  KEY.

The displayed option will flash (stored), indicating that it has been set.

PRESS THE  KEY.

NOTE: When set to close on torque, the actuator will apply the level of torque as set for **[tC]** in seating the valve (refer to **[tC]** page 22).

C3

Open Action

IQT actuators are designed to stop at the end of travel by torque limitation against the actuator stop bolts. Stop bolts should therefore be set to the precise stopping position required, refer to section 5.6.

IQTF actuators can be configured to close on torque or limit. Refer to valve manufacturers instructions.

 **Refer to valve manufacturer for recommended setting. In the absence of valvemaking instructions set "Open Limit".**

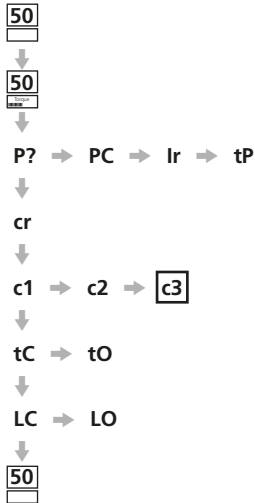

Using the + or - key display the required option.



[Ot] in the Setting Field Indicates Open on Torque - default setting.



[OL] in the Setting Field Indicates Open on Limit.

NOTE: When set to open on torque, the actuator will apply the level of torque as set for **[tO]** in back seating the valve (refer to **[tO]** page 23).

PRESS THE  KEY.

The displayed option will flash (stored), indicating that it has been set.

PRESS THE  KEY.

tC

Close Torque

The value of torque available in the close direction can be configured.

⚠ Refer to valve manufacturer for recommended value.

The closing torque value can be varied between 40% and Rated (100%), in 1% increments.

50



50



P? → PC → Ir → tP



cr



c1 → c2 → c3



tC → tO



LC → LO



50



Using the + and – keys, the display recommended value. In the absence of a recommended torque value, try a low setting and increase until satisfactory valve operation is achieved.

⚠ If the actuator fails to complete a closed valve operation due to the set torque being reached (Torque Trip CL Alarm, page 5) this may indicate a valve and/or process problem or change. It is the responsibility of the user to ensure the valve and process conditions are within specified operational limits before increasing the Set Close torque value.

PRESS THE  KEY.

The displayed value will flash (stored), indicating that it has been set.

Should the set level of torque be developed in closing, the actuator will torque trip and stop.

PRESS THE  KEY.

NOTE: Rated torque is quoted on the actuator nameplate.

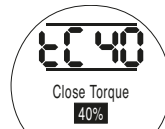

40% of Rated Torque

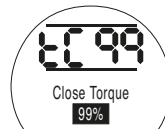

99% of Rated Torque



Rated Torque

tO Open Torque

The value of torque available in the open direction can be configured.

⚠ Refer to valve manufacturer for recommended value.

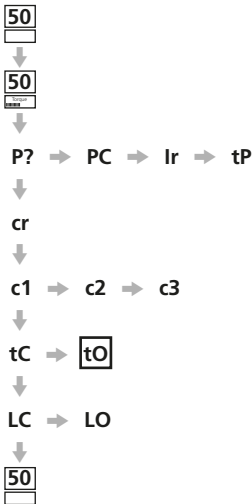

The opening torque value can be varied between 40% and Rated, in 1% increments. In addition “Boost” can be configured when no open torque protection is required.

⚠ BOOST SHOULD NOT BE SELECTED WHEN THE ACTUATOR HAS BEEN CONFIGURED TO OPEN ON TORQUE (refer to [C3] page 21) UNLESS BACK SEATING AT RATED TORQUE IS ACCEPTABLE.

Using the + and – keys, display the recommended torque value.

In the absence of a recommended torque value, try a low setting and increase until satisfactory valve operation is achieved.

⚠ If the actuator fails to complete a open valve operation due to the set torque being reached (Torque Trip OP Alarm, page 5) this may indicate a valve and/or process problem or change. It is the responsibility of the user to ensure the valve and process conditions are within specified operational limits before increasing the Set Open torque value.

NOTE: Rated torque is quoted on the actuator nameplate. Boost torque is at least 140% of Rated torque.

PRESS THE  KEY.

The displayed value will flash (stored), indicating that it has been set.

Should the set level of torque be developed in opening, the actuator will torque trip and stop.

PRESS THE  KEY.



Rated



Boost

In checking mode, on pressing the  key after reviewing open torque setting, the display will revert to valve position.

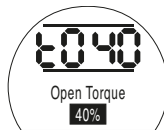

40%

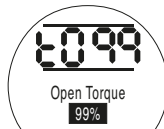

99%

LC Set Limit Closed

NOTE: It is possible to set the Open Limit Position [LO] first.

50



50



P? → PC → lr → tP



cr



c1 → c2 → c3



tC → tO



LC → LO



50

NOTE: When in checking mode Set Limit Closed [LC] does not appear.

With [LC] displayed



Limit Closed

Move valve manually to the closed position. Allow for overrun by winding actuator output open by 1/2 to 1 turn.

PRESS THE KEY.

The two bars will flash (stored) and the closed indicator lamp will illuminate, indicating closed limit position has been set.

PRESS THE KEY.

To check closed limit position hand wind valve open until the amber lamp illuminates. Wind valve back closed until the closed lamp illuminates.

LO Set Limit Open

50



50



P? → PC → lr → tP



cr



c1 → c2 → c3



tC → tO



LC → LO



50



NOTE: When in checking mode Set Limit Open [LO] does not appear.

With [LO] displayed



Limit Open

Move valve manually to the open position. Allow for overrun by winding actuator output closed by 1/2 to 1 turn.

PRESS THE KEY.

The two bars will flash (stored) and the open indicator lamp will illuminate, indicating open limit position has been set.

PRESS THE KEY.

The open symbol (refer to Fig. 3.3. page 4) should now appear.

AA Speed Setting

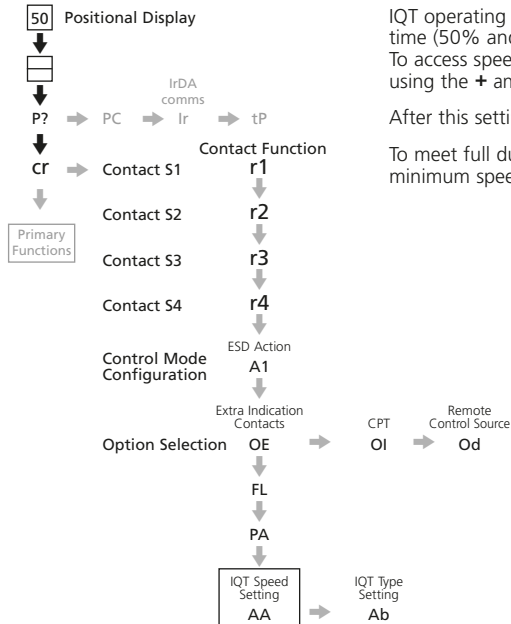

IQT operating time can be adjusted between 25% and 100% of the maximum time (50% and 100% for IQT2000). IQT are factory set at the maximum speed. To access speed setting **[AA]** screen, bus system **[OP]** has to be set to **[ON]**, using the + and - key.

After this setting, proceed to screen **[AA]**.

To meet full duty cycle performance, IQTM actuators are despatched with the minimum speed set.

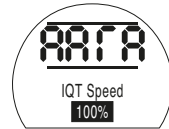

With **[AA]** displayed

Use the + and - key to select the required actuator operating time. The settings are displayed in percentage of maximum rated speed.

PRESS THE  KEY.

The displayed value will flash, indicating that it has been set.

All speed settings are adjustable in percentage increments. Any value of % outside of the range stated will not be accepted into the actuator memory.

NOTE: Mains power has to be on for speed setting to be carried out.

Return to Positional Display

50



50



P? → PC → Ir → tP



cr



c1 → c2 → c3



tC → tO



LC → LO



50



If the procedure has been followed as described, the positional display will indicate that the actuator is in the open position.

Select Remote control momentarily, using the red selector to exit setting procedure and then select required control: Local, Stop or Remote.

With the correct settings made electric operation can now be carried out safely.



Fig. 9

The Configuration Settings can be configured to suit site control and indication requirements. It is important that Basic Settings such as limits and torque switch settings are set before work commences on commissioning the Configuration Settings (refer to page 17).

The layout of the Configuration Settings accessed with the Setting Tool are detailed in Fig. 9.1. To successfully commission the Configuration Settings, information about the site or process control system will be required.

The supplied actuator Wiring Diagram details control and indication devices fitted to the actuator along with terminal connection detail and standard remote control wiring systems.

Power Off Setting

IQT allows settings to be viewed and set without mains power. To enable this function, engage handwheel drive and rotate until the output drive moves by one turn (refer to page 3). The Setting-Tool can now be used. As long as a Setting Tool key press takes place within the 30 seconds timeout period, Power Off Setting will remain enabled. If no infra-red Setting Tool communication takes place the display will return to indicating position. The actuator must then be operated by handwheel to re-enable Power Off Setting.

⚠ Settings and operation must be verified by electric operation and function test of the actuator to ensure correct operation.

NOTE: For IQT Battery Failsafe instructions, see Section 10 page 61.

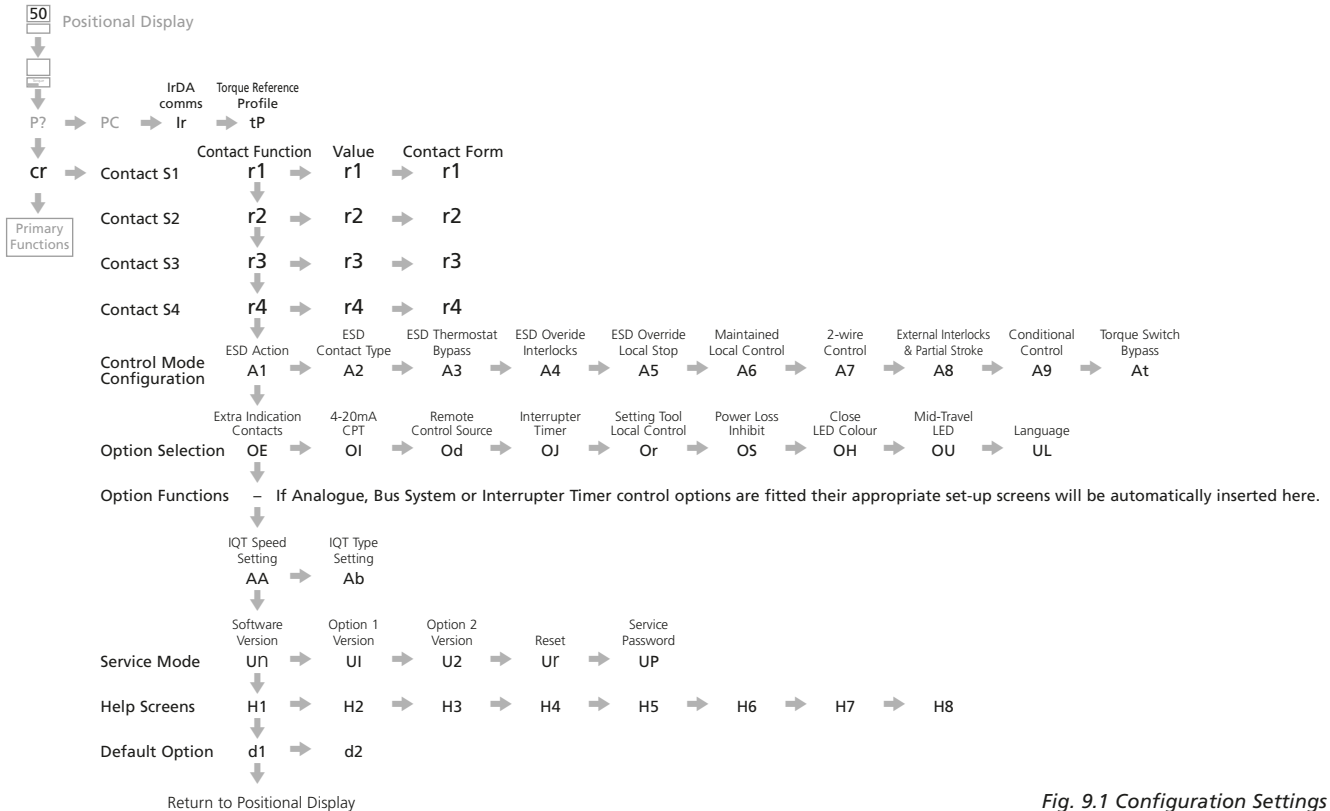

Fig. 9.1 Configuration Settings

CONFIGURATION SETTINGS

9.1	Accessing the Configuration Settings	29
9.2	Indication Contacts S1, S2, S3 and S4	30
9.3	Control Mode Configuration	32
9.4	Option Extra Indication Contacts S5–S8	35
9.5	Option CPT (4-20mA Indication)	36
9.6	Option Folomatic (Analogue Position Control)	37
9.7	Remote Control Source	40
9.8	Bus System Option Pakscan	41
9.9	Bus System Option Modbus	44
9.10	Bus System Option Profibus DP	47
9.11	Bus System Option DeviceNet	50
9.12	Bus System Positioning Control Settings	53
9.13	Option Interrupter Timer	55
9.14	Setting Tool Local Control	57
9.15	Inhibit Operation After Power Loss	57
9.16	Indicator LEDs	58
9.17	Display Language	58
9.18	Default Options	59
9.19	Actuator Type Setting	61
10.3	IQT Battery Failsafe Commissioning Instructions	64
11.2	Help Screens	73
11.3	IrDA Diagnostics and Configuration	78

Having established that the Basic Settings have been correctly set, the Configuration Settings can now be configured to suit site control and indication requirements.

It is possible to move through the various Configuration Settings as shown in Fig. 9.1 using the → and ↓ keys.

The actuator wiring diagram will indicate any options fitted.

Options Setting Tool Local Control [Or] and Power Loss Inhibit [OS] are standard features, their use being optional.

In order to display the Configuration Settings it is necessary to press the ↓ key until [Cr] appears.

If you have chosen to enter Configuration Settings in the checking mode the display will be as Fig. 9.2.

If you have chosen to enter Configuration Settings in the setting mode the display will be as Fig. 9.3 (refer to Section 7).



Fig. 9.2



Fig. 9.3

PRESS THE → KEY.

9.2 Indication Contacts S1, S2, S3 and S4

Indication contacts S1 [r1], S2 [r2], S3 [r3] and S4 [r4] may each be set to trip for any one of the following functions:

Code	Function (as displayed)
[CL]	Closed Limit
[OP]	Open Limit
[Po]	Position % Open
[rR]	Motor Running
[dC]	Closing
[dO]	Opening
[d?]	Moving
[HA]	Hand Operation
[bL]	Moving-Blinker
[UA]	Valve Alarm
[tC]	Torque Trip Close (direction)
[tO]	Torque Trip Open (direction)
[tt]	Torque Trip (any position)
[tI]	Torque Trip Mid (travel)
[St]	Motor Stalled
[LS]	Stop Selected
[Lo]	Local Selected
[RE]	Remote Selected
[CA]	Control Alarm
[ES]	ESD Active

[OI]	Open Interlock Active
[CI]	Close Interlock Active
[IL]	Interlock Active
[AA]	Actuator Alarm
[Ht]	Thermostat Tripped
[24]	24V Power Failure
[bA]	Battery Low
[rP]	Relay Parity
[PA]	Partial Stroke Active
[PE]	Partial Stroke Error

The S contact form can be set normally open [no] or normally closed [nc].

The procedures for setting up contacts S2, S3 and S4 are the same as those shown for S1.

Unless specified with order, the default settings for indication contacts are as follows:

S1 – [CL] Closed Limit [no]

S2 – [OP] Open Limit [no]

S3 – [CL] Closed Limit [nc]

S4 – [OP] Open Limit [nc]

r1

Contact S1 - Function

30

Using the + or – key display the desired function.

PRESS THE  KEY.

The displayed function will flash indicating that it has been set.

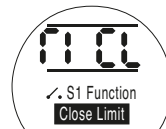

Contact S1 Configured to Trip at Valve Closed Limit

PRESS THE  KEY.

r1

Contact S1 - Value

This screen will only display if relay function is set to **[PO] Position Open**.

When the S contact function is set to **[PO]**, the required intermediate position value must be set.

No other contact function requires a value to be set.

The value can be set from 1% open to 99% open in 1% increments.

Using the + or – key, display the required value.

PRESS THE  KEY.

The displayed value will flash (stored) indicating that it has been set.



*Value Set to Indicate
25% Open*

PRESS THE  KEY.

r1

Contact S1 Contact Form

Use the + or – keys to select between **[NO] Normally Open** and **[NC] Normally Closed**.

PRESS THE  KEY.

The displayed option will flash (stored) indicating that it has been set.



*Contact S1 Configured as a
Normally Open Contact*

NOTE: If function **[PO] Position Open** is selected and it is configured as a normally open contact it will make at the set value with the actuator moving in the open direction.

To access S2–S4

PRESS THE  KEY.

9.3 Control Mode Configuration

The Control Mode Configuration affects how the actuator will respond under conditions of emergency shut down, local control, remote control interlocks, and 2-wire remote control. Also included is an unseating torque switch bypass function. Unless specified with order, the control mode configuration will be set as shown for default configuration on page 59.

If it is necessary to change the configuration follow the instructions in this section.

There are 10 configurable control functions:

Code	Function (as displayed)
[A1]	ESD Action
[A2]	ESD Contact Type
[A3]	ESD Override Stat
[A4]	ESD Override Interlocks
[A5]	ESD Override Local Stop
[A6]	Maintain Local Control
[A7]	2-wire Remote Priority
[A8]	Interlocks
[A9]	Conditional Control
[At]	Torque Switch Bypass.

A1 ESD Action

An active ESD signal applied to the actuator will override any existing or applied local or remote control signal. ESD can be configured to override the motor thermostat, active interlocks or local stop selection. Refer to A3, A4 and A5.

The default action under an active ESD signal is to stay put **[SP] Stay Put**.

Press the **+** or **-** key to select the required ESD action:

[OF] Off on ESD

[CL] Close on ESD

[SP] Stay Put on ESD

[OP] Open on ESD

PRESS THE  KEY.

The displayed option will flash (stored) indicating that it has been set.



A2 ESD Contact Type

The default setting for ESD Contact Type is **[nO] Normally Open**.

For actuators set to ESD **[nO] Normally Open** the ESD Signal must be applied to activate the ESD command. For ESD **[nC] Normally Closed** the signal must be removed to activate the command. Press the **+** or **-** key to choose the contact type.

PRESS THE  KEY.

The displayed option (stored) will flash indicating that it has been set.



Actuator Responds to a Normally Open ESD Contact (Signal Applied)

A3 ESD Override Thermostat

The default setting for ESD Override Thermostat is **[OF] No** during ESD. The thermostats remain in circuit and enabled during ESD.

The motor control thermostats can be bypassed during ESD as a factory set, hard-wired option only. Contact Rotork for information.

⚠ Danger: Actuator hazardous area certification is invalidated while the thermostats are bypassed.

[A3] should be set to reflect the factory set configuration of thermostat bypass.

During an ESD event:

[A3] = [OF] No, thermostats enabled

[A3] = [ON] Yes, thermostats bypassed



A4 ESD Override Interlocks

The default setting for ESD Override Interlocks is **[OF] No**. ESD action will not override an active interlock applied to the actuator.

If an applied ESD signal is required to override active interlocks causing the ESD action as set for A1, press the + or – key. The display will change to **[ON] Yes**.

PRESS THE  KEY.

The displayed option will flash (stored) indicating that it has been set.



A5 ESD Override Local Stop

The default setting for ESD Override Local Stop is **[OF] No**. ESD will not override local stop when selected.

If an applied ESD signal is required to override local stop causing the ESD action as set for A1, press the + or – key. The display will change to **[ON] Yes**.

PRESS THE  KEY.

The displayed option will flash (stored) indicating that it has been set.



A6 Maintain Local Control

The default setting for Local Actuator Pushbutton control is self-maintained **[ON] Yes**.

If non-maintained actuator pushbutton control is required (jogging, inching, push to run), press the + or – key. The display will change to **[OF] No**.

PRESS THE  KEY.

The displayed option will flash (stored) indicating that it has been set.



A7 2-wire Remote Priority

The default setting for 2-wire Remote Priority is **[SP] Stay Put**. If an open and closed remote control signal are applied simultaneously the actuator will stay put (stop if running). Refer to actuator wiring diagram or PUB002-002.

Use the + or – key to select the required priority:

[OP] Open

[SP] Stay Put

[CL] Close

PRESS THE  KEY.

The displayed option will flash (stored) indicating that it has been set.



2-wire Control – Stay Put Priority

A8 Interlocks

Actuators are delivered with the interlock facility disabled **[OF] Disabled**. Refer to the actuator wiring diagram or PUB002-002 for interlock control circuits.

To enable remote external interlocks press the **+** or **-** key.

The display will change to **[ON] Enabled**.

PRESS THE  KEY.

The displayed option will flash (stored) indicating that it has been set.



Note: If interlocking is required in only one direction, it will be necessary to connect a link between the actuator terminals associated with the other direction. Refer to wiring diagram.

A8 Partial Stroke

The actuator can be set to carry out a partial stroke test using a signal applied to the open interlock input to initiate a partial stroke test. Refer to wiring diagram.

The default for partial stroke/interlocks is **[OF] Disabled**.

To enable partial stroke testing press the **+** or **-** key.

The display will change to **[PS] Partial Stroke**.

PRESS THE  KEY.

The displayed option will flash (stored) indicating that it has been set.



To access partial stroke test settings **PRESS THE  KEY.**

Refer to Appendix A, page 84 for instructions on partial stroke settings.

A9 Conditional Control

Where a high level of safety integrity is required, Conditional Control can be configured. In this mode two discreet signals are required for remote operation. Remote control will be conditional on both a control signal (open or close) and the appropriate interlock signal being applied simultaneously. Failure of either or a spurious signal will not cause operation.

Interlocks **[A8]** must be set **[ON] Enabled**. Interlock signals are not required for local operation.

The default setting for conditional control is **[OF] Disabled**. To enable conditional control press the **+** or **-** key. The display will change to **[ON] Enabled**.

PRESS THE  KEY.

The displayed option will flash (stored) indicating that it has been set.



At Torque Switch Bypass

The default setting for Torque Switch Bypass is **[OF] Off**, the torque switches are not bypassed during the unseating movement.

To bypass the torque switches during the unseating movement press the **+** or **-** key.

The display will change to **[ON]**.

PRESS THE  KEY.

The displayed option will flash (stored) indicating that it has been set.

The torque switches will be bypassed from closed limit to 5% open when opening and from open limit to 95% when closing. Bypassing the torque switches makes torque in excess of rated and up to actuator stall available for unseating a "sticky" valve. Outside these positions the torque setting will revert to the values set for **[tC] Close Torque**, see page 22 and **[tO] Open Torque**, page 23.

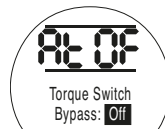

9.4 Option Extra Indication Contacts

Extra indication contacts S5 [r5], S6 [r6], S7 [r7] and S8 [r8] are available as an option.

Check actuator circuit diagram for inclusion.

When the Extra Contact Option is included the set-up procedure and available contact functions for S5 – S8 are identical to S1–S4 (refer to Section 9.2 page 30).

Unless specified with order the default setting for the extra indication contacts will be as follows:

S5 [r5] Close limit

S6 [r6] Open limit

S7 [r7] Torque trip mid

S8 [r8] Remote selected

NOTE: If the Extra Contact Option is not included in the actuator build, any settings made for S5–S8 will have no effect on the indication output of the actuator.

OE Display Extra Contact Set-up Screens

The action of turning on the Extra Contact Option makes an additional series of set-up screens available

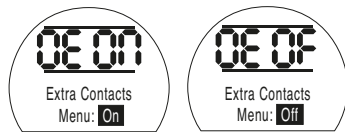

Press the + or – key to select the Extra Contact Option set-up screens [ON].

PRESS THE ← KEY.

The displayed option will flash (stored) indicating that it has been set.

PRESS THE ↓ KEY TO ACCESS S5 TO S8 SET-UP DISPLAYS.

The procedure for setting S5 to S8 is the same as that for S1 to S4 (refer to Section 9.2 page 30).

9.5 Option CPT [OI] – 4-20mA Indicator

Setting instructions for actuators including a CPT providing 4-20mA analogue position feedback.

The CPT is an optional extra. It may be internally or externally powered.

Check wiring diagram for inclusion and connection details.



With **[HI]** Displayed, the CPT operates **Close=4mA, Open=20mA**

If **Close=20mA, Open=4mA** is required, use the **+** or **-** key to change to **[LO]**.

PRESS THE  KEY.

The displayed option will flash (stored) indicating that the option has been set.

NOTE: If the actuator has options Folomatic and CPT, redefining the CPT, will require the Folomatic to be recommissioned (*refer to Section 9.6 Folomatic [OI] page 37*).

9.6 Option Folomatic – Analogue Control

Setting instructions for actuators including a Folomatic proportional controller for use in analogue valve position control.

The Folomatic is an optional control device. Check actuator wiring diagram for inclusion.

Before setting the parameters for Option Folomatic ensure Remote Control Source [Od] has been selected to [bo] in Section 9.7.

Folomatic set up screens will be automatically displayed when the option is fitted. Refer to actuator wiring diagram.

This instruction lists the Folomatic function displays in their sequence and assumes that all Folomatic functions are to be checked/set.

The actuator should be selected in Local or Stop with the analogue input signal connected to terminals 26 (+ve) and 27 (-ve) (refer to wiring diagram).

OI Folomatic Feedback

Before commissioning of the Folomatic functions can begin, the Folomatic Feedback must be set to suit the applied set point signal.



With **[HI]** displayed, a 20mA signal will correspond to the valve opening.

If a high input signal is required to correspond to valve closing use the **+** or **-** key to change to **[LO] CL=20mA**.

PRESS THE  KEY.

The displayed option will flash (stored) indicating that it has been set.

If setting **[OI]** is modified after commissioning the Folomatic, it will be necessary to recommission the Folomatic.

Press the  key to access the Folomatic set-up display menus.

FI Analogue Signal Type

Using the **+** or **-** key select **[I] Current** for current input signal or **[U] Voltage** for voltage input signal.

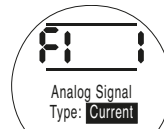

PRESS THE  KEY.

The displayed option will flash (stored) indicating that it has been set.

The signal type selected will determine what is displayed on the input signal range screen **[Fr] Analog Signal**.

Press the  key to display: **[Fr] Analog Signal**.

Fr Input Signal Range

Using the **+** or **-** key select for required signal within the range of 0–5mA or volts, 0–10mA or volts or 0–20mA or volts (i.e. 4–20mA).

If **[FI]** is set to **current**, mA ranges will be displayed. If **[FI]** is set to **Voltage**, voltage ranges will be displayed.

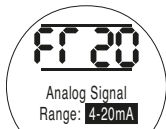

0–20mA Range Selected



0-20V Range Selected

PRESS THE  KEY.

The displayed option will flash (stored) indicating that it has been set.

Press the **→** key to display:
[FL] Low Set Point Position.

FL Valve Position LOW Set Point

APPLY MINIMUM SET POINT SIGNAL

Using the **+** or **-** key select:

[] [] Closed = valve closed
[00] to [99] = percentage open
[≡≡] Open = valve open

to correspond with the **LOW** set point signal.



PRESS THE  KEY.

The displayed value will flash (stored) indicating that it has been set.

Press the **→** key to display:
[FH] High Set Point Position.

FH Valve Position HIGH Set Point

APPLY MAXIMUM SET POINT SIGNAL

Using the **+** or **-** key select:

[] [] Closed = valve closed
[00] to [99] = percentage open
[≡≡] Open = valve open

to correspond with the **HIGH** set point signal.



PRESS THE  KEY.

The displayed value will flash (stored) indicating that it has been set.

Press the **→** key to display:
[Fd] Deadband.

Fd Deadband Adjustment

If the actuator hunts or responds unnecessarily to a fluctuating input signal the deadband must be increased. If more accurate control is required the deadband may be decreased.

Use the **+** or **-** key to select the deadband width. Range 00–99 corresponds to 0–9.9% of setpoint signal.

NOTE: Maximum deadband is 9.9% of valve stroke. Normally, minimum deadband should not be less than 1%.

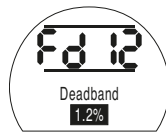

PRESS THE  KEY.

The displayed value will flash (stored) indicating that it has been set.

Press the **→** key to display:
[Ft] Motion Inhibit Time.

Ft Motion Inhibit Timer Adjustment

The motion inhibit timer introduces a delay in the actuator response to a rapidly fluctuating input signal, preventing unnecessary movement.

Once the system stabilises the actuator will respond to steady changes in the input signal as necessary.

Use **+** or **-** key to adjust motion inhibit time in seconds: range 0–99. Normally it is recommended that motion inhibit time should not be set to less than 5 seconds (*refer to note on page 57*).



PRESS THE KEY.

The displayed value will flash (stored) indicating that it has been set.

Press the  key to display:
[FA] Loss of Signal.

FA Action On Loss of Set Point Signal

Use **+** or **-** key to enable **[ON]** or disable **[OF]** action on loss of set point signal.

[ON] – Failsafe as determined by **[FF]**.

[OF] – Go to Low SP



PRESS THE KEY.

The displayed option will flash (stored) indicating that it has been set.

NOTE: Failsafe action "ON" will be effective only for systems using an offset or live zero signal range, for example 4–20mA.

[FF] will only be displayed if **[FA]** has been set to **[ON]**.

Press the  key to display:
[FF] Failsafe Action.

FF Failsafe Action

Failsafe action when **[FA] Loss of Signal** set to **[ON] Failsafe** only.

Use **+** or **-** key to select, on loss of input signal:

[Lo] – Go to Low SP position.

[SP] – Stay Put

[HI] – Go to High SP position.



PRESS THE KEY.

The displayed option will flash (stored) indicating that it has been set.

Commissioning of the Folomatic is now complete. Remote control may be selected.

FC Manual/Auto Selection

Using a switched input you can select between Folomatic (Auto) operation and Manual (hardwired remote) operation. This can be used in applications where you want the option to override the Folomatic to allow full manual control of the actuator from the control room.

Actuators dispatched will have this feature disabled as the default in order to minimise commissioning time. If you would like this feature enabled, use the **+** or **-** key to select **[on] Enabled**.



PRESS THE KEY.

The displayed option will flash (stored) indicating that it has been set.

Using the wiring diagram supplied with the actuator, follow the instructions on how to connect the Manual / Auto selection switch.

Commissioning of the Folomatic is now complete. Remote control may be selected.

9.7 Remote Control Source

The available forms of remote control are listed below:

- 1 - Standard hardwired control
- 2 - Analogue control-Option Folomatic
- 3 - Network control including:
 - Option Pakscan
 - Option Modbus
 - Option Profibus
 - Option Foundation Fieldbus
 - Option DeviceNet

The setting for Remote Control Source will depend on the type of remote control required and the option specified and fitted. Check actuator circuit diagram for remote control form.

Od Remote Control Source

The setting of Remote Control Source will be determined by the option that has been fitted, if any.

[RE] Hard-Wired Only: Pushbutton/relay contact control.

[oP] Network: Pakscan, Profibus, Modbus, Foundation Fieldbus or DeviceNet control.

[bo] Folomatic: Analogue Proportional control.

[OF] Remote Disabled: Remote control disabled.

To change the remote source press the **+** or **-** key until the required setting is displayed.

PRESS THE  KEY.

The displayed option will flash (stored) indicating that it has been set.



*Standard Hardwired
Remote Control*

9.8 Bus System Option Pakscan

Setting instructions for actuators including an optional Pakscan Field Control Unit – check wiring diagram for inclusion.

Before setting the parameters for Option Pakscan ensure Remote Control Source [Od] has been selected to [oP] in Section 9.7. (refer to page 40)

PA Pakscan Node Address

The actuator Pakscan Field Control Unit must be allocated a unique loop node address.

The actuator must be in “Loopback” and isolated from Pakscan loop traffic for its address to be set or changed. Loopback can be achieved in two ways:

1. Turn OFF the master station.
2. Isolate the actuator from the 2-wire control loop both in & out.

Using the + or – keys display the required loop address.

Address to be set within the range 01-240 (01-F0 Hexadecimal). (refer to table on page 81).



PRESS THE ← KEY.

The displayed option will flash (stored) indicating that it has been set.

Press the → key to display:
[Pb] Baud Rate.

Pb Pakscan Baud Rate

The actuator Pakscan Field Control Unit baud rate must be set to the loop baud rate. For a Pakscan 2-wire control loop the selected baud rate must be common to the master station and all the field control units included in the loop.

The actuator must be in “Loopback” and isolated from Pakscan loop traffic for its baud rate to be set or changed.

Loopback can be achieved in two ways:

1. Turn OFF the master station.
2. Isolate the actuator from the 2-wire control loop both in & out.

Using the + or – keys display the required baud rate.

[01] = 110 baud

[03] = 300 baud

[06] = 600 baud

[12] = 1200 baud

[24] = 2400 baud



PRESS THE ← KEY.

The displayed option will flash (stored) indicating that it has been set.

Press the → key to display:
[PF] Aux I/P Mask.

PF

Pakscan Remote Auxiliary Input Mask

The IQT actuator has the facility to accept 4 auxiliary inputs (AUX1–AUX4). These are used when supplementary remote control or digital auxiliary inputs are required in addition to the standard control and feedback features incorporated into the Pakscan card. It is also possible to have a combination of both remote control and volt-free inputs to provide, for example, open and close control as well as a high and low tank level alarm indication, supplied via an external transducer.

The hexadecimal number displayed under PF can be considered as a “software mask”. It is this mask that tells the Pakscan card what type of input to expect, control or input signal, and what form the input will be, normally open or normally closed (*refer to page 81 for Binary, Hexadecimal and Decimal Conversion Table*).

To decipher the mask the number needs to be split into two separate hexadecimal characters, each of which can be sub-divided into 4 binary bits. The first 4 bits represent the function and the second 4 represent the input source (known as invert). Pictorially this can be represented as:

	Left side hex character	Right side hex character
	Aux 4 to 1 (function)	AUX 4 to 1 (Invert)
Bits	4 3 2 1	4 3 2 1

When used for remote control of the actuator bits 4 to 1 of the function character have been designated as follows:

Bit 4 (AUX4)	–	ESD
Bit 3 (AUX3)	–	Stop (Maintain)
Bit 2 (AUX2)	–	Close
Bit 1 (AUX1)	–	Open

(When used for digital signal inputs they are simply designated as AUX 4 to AUX 1)

Rules

1. Function bit set to “0”

Any function bit set to “0” indicates that the particular aux input is to be treated as a digital signal for field status reporting, e.g. a level switch or motor running status.

If the corresponding invert bit is set to a “0”, an open contact is reported as a logic “1” and a closed contact is reported as a logic “0” (i.e. this will invert the input).

If the corresponding invert bit is set to a “1”, an open contact is reported as a logic “0” and a closed contact is reported as a logic “1” (i.e. this gives a noninverting input).

2. Function bit set to “1”

Any function bit set to “1” indicates that the particular aux input is to be treated as a digital command to operate the actuator.

When the corresponding invert bit is set to a “0” this represents an N.C. contact as being the command source, i.e. a closing contact de-energises the input and an opening contact energises the input.

When the corresponding invert bit is set to a “1”, this represents an N.O. contact as being the command source, i.e. a closing contact energises the input and an opening contact de-energises the input.

3. ESD Control

When using ESD (aux input 4), the ESD contact mode setting **[A2]** should be set to the default value of **[NO]**. The **[A1]**–ESD direction setting should be set to either Open or Close the valve (*refer to page 32*).

4. Stop (Maintain) Control

When energised this will make the Aux input Open/Close/ESD control push-to-run, (non-maintained). When de-energised, the Aux input Open/Close/ESD control will be maintained.

PF Pakscan Remote Auxiliary Input (continued)

5. Remote I/P Setting

Ensure that the correct **[Od] Control Type** setting is selected (refer to page 40).

For Pakscan this is **[oP] Network**.

The factory default for **[PF] Aux I/P Mask** is **[OF] 0000 1111**.

Examples

1. The full range of remote controls is needed. Open and Close are NO and ESD and Stop/maintain is NC.

Aux I/P 4 3 2 1

Function 1 1 1 1 = F

Invert 0 0 1 1 = 3 i.e. set [PF] to [F3]

2. Open and close control is required along with 2 inverted digital signal inputs (Note that with this setting the open and close commands will be maintained.)

Aux I/P 4 3 2 1

Function 0 0 1 1 = 3

Invert 0 0 1 1 = 3 i.e. set [PF] to [33]

3. Only an ESD input is needed. The requirement is for push to run control with a NO contact input.

Aux I/P 4 3 2 1

Function 1 1 0 0 = C

Invert 1 0 0 0 = 8 i.e. set [PF] to [C8]

PF Pakscan Remote Auxiliary Input

Using the **+** or **-** keys display the required mask setting.



Auxiliary Input Mask [OF]

PRESS THE ← KEY.

The displayed option will flash (stored) indicating that it has been set.

For Pakscan module positioning settings **[OF]**, refer to page 53.

If Pakscan positioning control is required, **PRESS THE ↓ KEY.**

Display **[FL] Low Set Point Position** (refer to page 53).

9.9 Bus System Option Modbus [OP]

Setting instructions for actuators including an optional Modbus RTU module – check wiring diagram for inclusion.

Before setting the parameters for Option Modbus ensure Remote Control Source [Od] has been selected to [oP] in Section 9.7. (refer to page 40).

⚠ The actuator power must be cycled for the changes to take effect.

PA Modbus Node Address

The Modbus module must be allocated a unique address.

To set the address the Modbus module must be isolated from the host by disconnecting the RS485 highway or turning off the host device.

Using the **+** or **-** keys display the required address.

Address to be set within the range (01-247 to F7 Hexadecimal). If an address value outside this range is entered, the address set will revert to 01 (for 00) or F7 (for value above F7).



PRESS THE ← KEY.

The displayed option will flash (stored) indicating that it has been set.

Press the → key to display:
[Pb] Baud Rate.

Pb Modbus Baudrate

The Modbus module must be set to the RS485 highway baudrate. To set the baudrate the Modbus module must be isolated from the host by disconnecting the RS485 highway or turning off the host device.

Using the **+** or **-** keys display the required baudrate:

[01] = 110	[06] = 600
[03] = 300	[24] = 2400
[12] = 1200	[96] = 9600
[48] = 4800	[38] = 38400
[19] = 19200	[11] = 115200
[57] = 57600	



PRESS THE ← KEY.

The displayed option will flash (stored) indicating that it has been set.

Press the → key to display:
[PF] Aux I/P Mask.

The IQT actuator has the facility to accept 4 auxiliary inputs (AUX1 – AUX4). These are used when supplementary remote control or digital auxiliary inputs are required in addition to the standard control and feedback features incorporated into the Modbus module. It is also possible to have a combination of both remote control and volt-free inputs to provide, for example, open and close control as well as a high and low tank level alarm indication, supplied via an external transducer.

The hexadecimal number displayed under PF can be considered as a “software mask”. It is this mask that tells the Modbus module what type of input to expect, control or input signal, and what form the input will be, normally open or normally closed (*refer to page 81 for Binary, Hexadecimal and Decimal Conversion Table*).

To decipher the mask the number needs to be split into two separate hexadecimal characters, each of which can be sub-divided into 4 binary bits. The first 4 bits represent the function and the second 4 represent the input source (known as invert). Pictorially this can be represented as:

	Left side hex character Aux 4 to 1 (function)	Right side hex character AUX 4 to 1 (invert)
Bits	4 3 2 1	4 3 2 1

When used for remote control of the actuator bits 4 to 1 of the function character have been designated as follows:

Bit 4 (AUX4)	–	ESD
Bit 3 (AUX3)	–	Stop (Maintain)
Bit 2 (AUX2)	–	Close
Bit 1 (AUX1)	–	Open

(When used for digital signal inputs they are simply designated as AUX 4 to AUX 1.)

Rules

1. Function bit set to “0”

Any function bit set to “0” indicates that the particular aux input is to be treated as a digital signal for field status reporting, e.g. a level switch or motor running status.

If the corresponding invert bit is set to a “0”, an open contact is reported as a logic “1” and a closed contact is reported as a logic “0” (i.e. this will invert the input).

If the corresponding invert bit is set to a “1”, an open contact is reported as a logic “0” and a closed contact is reported as a logic “1” (i.e. this gives a noninverting input).

2. Function bit set to “1”

Any function bit set to “1” indicates that the particular aux input is to be treated as a digital command to operate the actuator.

When the corresponding invert bit is set to a “0” this represents an N.C. contact as being the command source, i.e. a closing contact de-energises the input and an opening contact energises the input.

When the corresponding invert bit is set to a “1”, this represents an N.O. contact as being the command source, i.e. a closing contact energises the input and an opening contact de-energises the input.

3. ESD Control

When using ESD (aux input 4), the ESD contact mode setting **[A2]** should be set to the default value of **[NO]**. The **[A1]**–ESD direction setting should be set to either Open or Close the valve (*refer to page 32*).

4. Stop (Maintain) Control

When energised this will make the Aux input Open/Close control push-to-run. When de-energised, the Aux input Open/Close control will be maintained. ESD is always push to run (non maintained).

5. Remote I/P Setting

Ensure that the correct **[Od] Control Type** setting is selected (*refer to page 40*).

For Modbus this is **[OP] Network**.

The factory default for **[PF] Aux I/P Mask** is **[OF] 0000 1111**.

Examples

1. The full range of remote controls is needed. Open and Close are NO and ESD and Stop/maintain is NC.

Aux I/P 4 3 2 1

Function 1 1 1 1 = F

Invert 0 0 1 1 = 3 i.e. set [PF] to [F3]

2. Open and close control is required along with 2 inverted digital signal inputs. (Note that with this setting the open and close commands will be maintained.)

Aux I/P 4 3 2 1

Function 0 0 1 1 = 3

Invert 0 0 1 1 = 3 i.e. set [PF] to [33]

3. Only an ESD input is needed. The requirement is for push to run control with a NO contact input.

Aux I/P 4 3 2 1

Function 1 1 0 0 = C

Invert 1 0 0 0 = 8 i.e. set [PF] to [C8]

Using the **+** or **-** keys display the required mask setting.



PRESS THE  KEY.

The displayed option will flash (stored) indicating that it has been set.

Press the **→** key to display:
[PP] Modbus Parity.

Where Modbus parity bit detection is used the module must be set with the parity bit setting of the host.

Using the **+** or **-** keys display the required parity bit:

[No] None (no) parity bit

[En] Even parity bit

[Od] Odd parity bit



No Parity Bit

PRESS THE  KEY.

The displayed option will flash (stored) indicating that it has been set.

For Modbus module positioning settings and action on loss of signal setting, *refer to Section 9.12 page 53*.

If Modbus positioning control and action on loss of communication are required, **PRESS THE  KEY.**

Display **[FL] Low Set Point Position** (*refer to page 53*).

9.10 Bus System Option Profibus DP [OP]

Setting instructions for actuators including an optional Profibus DP module – check wiring diagram for inclusion.

Before setting the parameters for Option Profibus ensure Remote Control Source [Od] has been selected to [oP] in Section 9.7. (refer to page 40).

⚠ Any settings made locally at the actuator may be overwritten by the host on startup unless the GSD files are locked on the Profibus card. Refer to publication S420E available from www.rotork.com

⚠ The actuator power must be cycled for the changes to take effect.

PA Profibus Node Address

The Profibus DP module must be allocated a unique address.

To set the address the Profibus module must be isolated from the host by disconnecting the RS485 highway or turning off the host device.

Using the + or – keys display the required address.

Address to be set within the range (01-126 to 7E Hexadecimal) (refer to page 81 for conversion). If an address value outside this range is entered, the address set will revert to 01 (for 00) or 7E (for value above 7E).



PRESS THE ← KEY.

The displayed option will flash (stored) indicating that it has been set.

Press the → to display:
[Pb] Baud Rate.

⚠ [Pb] has no relevance for the Rotork Profibus DP Mk.2 card.

Therefore, if the Rotork Profibus DP Mk.2 card is fitted, press the → to display:
[PF] Aux I/P Mask.

The IQT actuator has the facility to accept 4 auxiliary inputs (AUX1–AUX4). These are used when supplementary remote control or digital auxiliary inputs are required in addition to the standard control and feedback features incorporated into the Profibus module. It is also possible to have a combination of both remote control and volt-free inputs to provide, for example, open and close control as well as a high and low tank level alarm indication, supplied via an external transducer.

The hexadecimal number displayed under PF can be considered as a “software mask”. It is this mask that tells the Profibus module what type of input to expect, control or input signal, and what form the input will be, normally open or normally closed (*refer to page 81 for Binary, Hexadecimal and Decimal Conversion Table*).

To decipher the mask the number needs to be split into two separate hexadecimal characters, each of which can be sub-divided into 4 binary bits. The first 4 bits represent the function and the second 4 represent the input source (known as invert). Pictorially this can be represented as:

	Left side hex character Aux 4 to 1 (function)	Right side hex character AUX 4 to 1 (invert)
Bits	4 3 2 1	4 3 2 1

When used for remote control of the actuator bits 4 to 1 of the function character have been designated as follows:

Bit 4 (AUX4)	–	ESD
Bit 3 (AUX3)	–	Stop (Maintain)
Bit 2 (AUX2)	–	Close
Bit 1 (AUX1)	–	Open

(When used for digital signal inputs they are simply designated as AUX 4 to AUX 1.)

Rules

1. Function bit set to “0”

Any function bit set to “0” indicates that the particular aux input is to be treated as a digital signal for field status reporting, e.g. a level switch or motor running status.

If the corresponding invert bit is set to a “0”, an open contact is reported as a logic “1” and a closed contact is reported as a logic “0” (i.e. this will invert the input).

If the corresponding invert bit is set to a “1”, an open contact is reported as a logic “0” and a closed contact is reported as a logic “1” (i.e. this gives a noninverting input).

2. Function bit set to “1”

Any function bit set to “1” indicates that the particular aux input is to be treated as a digital command to operate the actuator.

When the corresponding invert bit is set to a “0” this represents an N.C. contact as being the command source, i.e. a closing contact de-energises the input and an opening contact energises the input.

When the corresponding invert bit is set to a “1”, this represents an N.O. contact as being the command source, i.e. a closing contact energises the input and an opening contact de-energises the input.

3. ESD Control

When using ESD (aux input 4), the ESD contact mode setting **[A2]** should be set to the default value of **[NO]**. The **[A1]**–ESD direction setting should be set to either open or close the valve (*refer to page 32*).

4. Stop/Maintain Control

When energised this will make the Aux input Open/Close control push to run. When de-energised, the Aux input Open/Close control will be maintained. ESD is always push to run (non maintained).

PF Profibus Remote Auxiliary Input (continued)

5. Remote Source Setting [Od]

Ensure that the correct [Od] Control Type setting is selected (refer to page 40).

For Profibus this is [OP] Network.

The factory default for [PF] Aux I/P Mask is [OF] 0000 1111.

Examples

1. The full range of remote controls is needed. Open and Close are NO and ESD and Stop/maintain is NC.

Aux I/P 4 3 2 1

Function 1 1 1 1 = F

Invert 0 0 1 1 = 3 i.e. set [PF] to [F3]

2. Open and close control is required along with 2 inverted digital signal inputs. (Note that with this setting the open and close commands will be maintained.)

Aux I/P 4 3 2 1

Function 0 0 1 1 = 3

Invert 0 0 1 1 = 3 i.e. set [PF] to [33]

3. Only an ESD input is needed. The requirement is for push to run control with a NO contact input.

Aux I/P 4 3 2 1

Function 1 1 0 0 = C

Invert 1 0 0 0 = 8 i.e. set [PF] to [C8]

PF Profibus Remote Auxiliary Input

Using the + or – keys display the required mask setting.



PRESS THE ← KEY.

The displayed option will flash (stored) indicating that it has been set.

If Profibus positioning control and action on loss of communication are required, **PRESS THE ↓ KEY.**

Display [FL] Low Set Point Position (refer to page 53).

9.11 Option DeviceNet

Setting instructions for actuators including an optional DeviceNet DFU module – check wiring diagram for inclusion.

Before setting the parameters for Option DeviceNet ensure Remote Control Source [Od] has been selected to [oP] in section 9.7. (refer to page 40).

 **The actuator power must be cycled for the changes to take effect.**

PA DeviceNet Node Address

The DeviceNet module must be allocated a unique address.

Using the + or – keys display the required address.

Address to be set within the range (01-63 to 3F Hexadecimal). See page 81 for conversion. If an address value outside this range is entered, the address set will revert to 01 (for 00) or 3F (for value above 3F).



PRESS THE ← KEY.

The displayed option will flash (stored) indicating that it has been set.

Press the → key to display:
[Pb] Baud Rate.

Pb DeviceNet Baudrate

The DeviceNet module must be set to the DeviceNet highway baudrate.

Using the + or – keys display the required baudrate:

[01] = 125 k baud

[03] = 250 k baud

[06] = 500 k baud



PRESS THE ← KEY.

The displayed option will flash (stored) indicating that it has been set.

Press the → key to display:
[PF] Aux I/P Mask.

The IQT actuator has the facility to accept 4 auxiliary inputs (AUX1–AUX4). These are used when supplementary remote control or volt free digital auxiliary inputs are required in addition to the standard control and feedback features incorporated into the DeviceNet module. It is also possible to have a combination of both remote control and volt free inputs to provide, for example, open and close control as well as a high and low tank level alarm indication, supplied via an external transducer.

The hexadecimal number displayed under PF can be considered as a “software mask”. It is this mask that tells the DeviceNet module what type of input to expect, control or input signal, and what form the input will be, normally open or normally closed.

To decipher the mask the number needs to be split into two separate hexadecimal characters, each of which can be sub-divided into 4 binary bits. The first 4 bits represent the function and the second 4 represent the input source (known as invert). Pictorially this can be represented as:

	Left side hex character Aux 4 to 1 (function)	Right side hex character AUX 4 to 1 (Invert)
Bits	4 3 2 1	4 3 2 1

When used for remote control of the actuator bits 4 to 1 of the function character have been designated as follows:

Bit 4 (AUX4)	–	ESD
Bit 3 (AUX3)	–	Stop (Maintain)
Bit 2 (AUX2)	–	Close
Bit 1 (AUX1)	–	Open

(When used for digital signal inputs they are simply designated as AUX 4 to AUX 1.)

Rules

1. Function bit set to “0”

Any function bit set to “0” indicates that the particular aux input is to be treated as a digital signal for field status reporting, e.g. a level switch or motor running status. If the corresponding invert bit is set to a “0”, an open contact is reported as a logic “1” and a close contact is reported as a logic “0” (i.e. this will invert the input).

If the corresponding invert bit is set to a “1”, an open contact is reported as a logic “0” and a close contact is reported as a logic “1” (i.e. this gives a non-inverting input).

2. Function bit set to “1”

Any function bit set to “1” indicates that the particular aux input is to be treated as a digital command to operate the actuator.

When the corresponding invert bit is set to a “0” this represents an N.C. contact as being the command source, i.e. a closing contact de-energises the input and an opening contact energises the input.

When the corresponding invert bit is set to a “1”, this represents an N.O. contact as being the command source, i.e. a closing contact energises the input and an opening contact de-energises the input.

3. ESD Control

When using ESD (aux input 4), the ESD contact mode setting **[A2]** should be set to the default value of **[NO]**. The **[A1]**–ESD direction setting should be set to either open or close the valve (*refer to page 32*).

4. Stop (Maintain) Control

When energised this will make the Aux input Open/Close control push-to-run. When de-energised, the Aux input Open/Close control will be maintained. ESD is always push to run (non maintained).

PF

DeviceNet Remote Auxiliary Input (continued)

5. Remote I/P Setting

Ensure that the correct **[Od] Control Type** setting is selected (*refer to page 40*).

For DeviceNet this is **[OP] Network**.

The factory default for **[PF] Aux I/P Mask** is **[OF] 0000 1111**.

Examples

1. The full range of remote controls is needed. Open and Close are NO and ESD and Stop/maintain is NC.

Aux I/P 4 3 2 1

Function 1 1 1 1 = F

Invert 0 0 1 1 = 3 i.e. set [PF] to [F3]

2. Open and close control is required along with 2 inverted digital signal inputs. (Note that with this setting the open and close commands will be maintained.)

Aux I/P 4 3 2 1

Function 0 0 1 1 = 3

Invert 0 0 1 1 = 3 i.e. set [PF] to [33]

3. Only an ESD input is needed. The requirement is for push to run control with a NO contact input.

Aux I/P 4 3 2 1

Function 1 1 0 0 = C

Invert 1 0 0 0 = 8 i.e. set [PF] to [C8]

Using the **+** or **-** keys display the required mask setting.



PRESS THE  KEY.

The displayed option will flash (stored) indicating that it has been set.

For DeviceNet module positioning settings and action on loss of signal setting, *refer to page 53*.

9.12 Bus System Positioning Control Settings

If the system control strategy for Pakscan, Modbus, DeviceNet or Profibus requires intermediate valve travel positioning to a "DV" (Desired Value - value corresponding to required position), the control parameters in this section need to be set. "Action on Loss of Signal" parameters apply only to Modbus and Profibus systems.

Limited Range Positioning is a selectable option whereby positioning limits, 0% and 100%, can be at different positions to those used for digital Closed and Open limit commands. Limited range positioning can be set using the **[FL] Low Set Point Position** and **[FH] High Set Point Position** screens.

It should be noted that the actuator will respond to a digital Open or Close host command by moving the valve to the set limits irrespective of settings made for positioning control.

Settings for Deadband and Motion Inhibit Time affect accuracy and response time.

⚠ Any settings made locally at the actuator may be overwritten by the host on startup unless the GSD files are locked on the Profibus card. Refer to publication S420E available from www.rotork.com

FL Bus System Valve Position at 0% DV

[FL] Low Set Point Position is the position to which the actuator will move if a 0% command is sent.

Note that the position set for **[FL]** will be reported to the host as 0%. The actuator display will report % open in the range set by the limits.

The default setting is for 0% to be the Close limit.

Use the **+** or **-** key to select the desired valve position for a 0% command.



0% DV = Valve Closed

PRESS THE ← KEY.

The displayed option will flash (stored) indicating that it has been set.

Press the **→** key to display:
[FH] High Set Point Position.

FH Bus System Valve Position at 100% DV

[FH] High Set Point Position is the position to which the actuator will move if a 100% command is sent.

Note that the position set for **[FH]** will be reported to the host as 100%. The actuator display will report % open in the range set by the limits.

The default setting is for 100% to be the Open limit.

Use the **+** or **-** key to select the desired valve position for a 100% command.

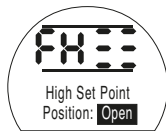

100% DV = Valve Open

PRESS THE ← KEY.

The displayed option will flash (stored) indicating that it has been set.

Press the **→** key to display:
[Fd] Deadband.

Fd Bus System Deadband Adjustment

53

All positioning commands are subject to a deadband tolerance.

The deadband sets the expected positioning accuracy of the actuator and is dependent on various factors including, actuator output speed, number of turns and valve torque. If the deadband is set too low the valve may "hunt" around the set point.

Use the **+** or **-** key to display the required setting:

[00] to [99] – 0% to 9.9% of valve stroke.

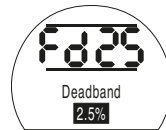

PRESS THE ← KEY.

The displayed option will flash (stored) indicating that it has been set.

Press the **→** key to display:
[Ft] Motion Inhibit Time.

Ft Bus System Motion Inhibit Time (MIT)

MIT sets the minimum time between successive position commands being actioned. It is used in situations to reduce the number of starts per hour and to smooth out fluctuations if continuous positioning is implemented.

Setting the longest possible time while maintaining acceptable control will maximise the life of the motorised valve.

Use the **+** or **-** key to display the required setting:

[00] to **[99]** = 0 to 99 seconds.



PRESS THE  KEY.

The displayed option will flash (stored) indicating that it has been set.

Press the **→** key to display:

[FA] Loss of Signal
(Modbus, Profibus & DeviceNet only).

FA Modbus, Profibus & DeviceNet Action on Loss of Signal

Modbus, Profibus & DeviceNet modules can be set to respond on loss of host communication by positioning the valve. Modbus checks for a loss of general highway communications whereas Profibus & DeviceNet check for a loss of communications addressed specifically to themselves.

The default setting is off **[OF]** and the default timeout is 255 sec.

Use the **+** or **-** key to display the required setting:

[ON] Failsafe as determined by setting **[FF]**

[OF] Go to Low SP position.



Failsafe Action Enabled

PRESS THE  KEY.

The displayed option will flash (stored) indicating that it has been set.

Press the **→** key to display:

[FF] Failsafe Action.

FF Modbus, Profibus & DeviceNet Failsafe Action

Modbus, Profibus & DeviceNet failsafe action when **[FA]** is enabled.

Use the **+** or **-** key to display the required setting:

[Lo] Go to Low SP position.

[SP] Stay put

[Hi] Go to High SP position.



PRESS THE  KEY.

The displayed option will flash (stored) indicating that it has been set.

9.13 Option Interrupter Timer

Setting instructions for actuator including an interrupter timer.

The interrupter timer enables pulsed “stop/start” operation by the actuator as a response to local and remote control commands.

This effectively increases the valve stroke time and can be adjusted to prevent hydraulic shock (water hammer) and flow surges in pipelines.

The interrupter timer is an optional extra – check wiring diagram for inclusion.

OJ Interrupter Timer Enabled/Disabled

When fitted, the timer will be made available for operation.

The interrupter cannot be enabled or disabled using the Setting Tool.

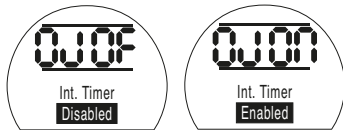

Interrupter Timer Disabled Interrupter Timer Enabled

When the timer option is available an additional series of settings can be accessed by pressing the ↓ key.

NOTE: If the timer option is not available pressing the ↓ key will not access setting.

Press the ↓ key to display interrupter timer set-up screens.

Jd Interrupter Timer Direction

The default for timer direction is [CL], timer operation will **start in closing** and **stop in opening** – pulsing operation around the close position.

If pulsing operation is required to stop in closing and start in opening – around the open position, use the + or – key.

The display will change to [OP] Opening.

PRESS THE ↶ KEY.

The displayed option will flash (stored) indicating that it has been set.



Pulsed Operation Around the Closed Position

NOTE: Instructions [JC] and [JO] are for timer operation around the Closed position. For timing around the Open position, read stop for start [JC] and start for stop [JO].

Press the → key to display: [JC] **Timer Start Position.**

JC Position in Valve Closing Stroke for Timer to Start

Using the + or – key select the position for the **TIMER TO START WHEN THE VALVE IS CLOSING.**

[] [] **Closed** = valve closed
[00] to [99] = percentage open
[≡≡] **Open** = valve open



Timer Set to Start Pulsing when Closing Valve Reaches 25% Open

PRESS THE ↶ KEY.

The displayed option will flash (stored) indicating that it has been set.

If the timing is not required in the closing stroke select [JC] to [] valve closed position.

Press the → key to display: [JO] **Timer Stop Position.**

JO Position in Valve Opening Stroke for Timer to Stop

Using the + or – key select the position for the **TIMER TO STOP WHEN THE VALVE IS OPENING**.

- [] Closed = valve closed
- [00] to [99] = percentage open
- [≡≡] Open = valve open



Timer Set to Stop Pulsing when Opening Valve Reaches 25% Open

PRESS THE KEY.

The displayed option will flash (stored) indicating that it has been set.

If timing is not required in the opening stroke select [JO] to [] .

Press the key to display: **[Jn] Timer On Time**.

Jn Contactor On Time

Using the + or – key select the actuator run period in the range 1–99 seconds.



Actuator Run Period Set for 5 Seconds

PRESS THE KEY.

The displayed option will flash (stored) indicating that it has been set.

Press the key to display: **[JF] Timer Off Time**.

JF Contactor Off Time

Using the + or – key select the actuator stop period in the range 1–99 seconds.



Actuator OFF Period Set for 25 Seconds

PRESS THE KEY.

The displayed option will flash (stored) indicating that it has been set.

Press the key to display: **[JE] Timer Override ESD** (refer to note on Page 57).

JE ESD Override Interrupter Timer

The interrupter timer may be overridden when the actuator is under ESD signal command. This will mean the actuator will run to limit without “stop/start” action under ESD command.

Refer to **[A1] – [A3]** (refer to page 32 for ESD settings).

The default for ESD override interrupter timer is **[OF] No**. The interrupter timer will continue “stop/start” action during ESD action.

If ESD must override the timer use the + or – to display **[ON] Yes**.



ESD Override Timer OFF

PRESS THE KEY.

The displayed option will flash (stored) indicating that it has been set.

Example

An actuator fitted with the interrupter timer and set as the example shown in these instructions would operate at:

Rated speed from full Open to 25% Open.

1/6 rated speed from 25% Open to Fully Closed and from Fully Closed to 25% Open.

Rated speed from 25% Open to Fully Open.

Note

With a Folomatic option fitted *and* the Interrupter Timer enabled, the Folomatic Motion Inhibit Timer must be adjusted to the same time as that set for the Interrupter Timer "contactor off".

Failure to do so will cause the actuator response to defer to the lower time which may cause control or process problems.

For "ON" and "OFF" times in excess of 99 seconds apply to Rotork.

9.14 Setting Tool Local Control [Or]

The default setting for Setting Tool Local Control is **[OF] Control Disabled**.

To enable Setting Tool Control press the + or – key to select **[ON]**.

PRESS THE ← KEY.

The displayed option will flash (stored) indicating that it has been set.

With the red control selector in Local, the Setting Tool control keys are active (refer to page 12).



Local Setting Tool Control Enabled

Vandal resistant actuators ONLY (red/black selectors not supplied). For control, the selection of **[O*] Vandal Resist** is as follows:

[ON] Local Only.

[OF] Control Disabled.

[RE] Remote Only.

9.15 Inhibit Operation After Power Loss [OS]

⚠ The default setting for this protection option is disabled [OF]. When disabled it is important that the actuator is not manually operated during a power failure if the battery is low as changes in position cannot be tracked - refer to page 6 for battery level status display. Should this occur the limits must be reset before electric operation takes place- refer to LC/LO page 27. Locking the hand auto lever can prevent manual operation - refer to Section 3.1, page 3.



The protection may be enabled by using the + or – key to select **[ON]**

PRESS THE ← KEY.

The displayed option will flash (stored) indicating that it has been set.

When protection is enabled, on power up if a low battery is detected, the actuator will inhibit electrical operation and display Power Loss Inhibit via actuator alarm display (refer to page 5) and the monitor relay will de-energise. Limits must reset and the battery replaced – refer to page 67.

Press the → key to display: **[OH] Close Colour.**

9.16 Indicator LEDs

The colour of the LEDs on the IQT display are user configurable. These menu screens allow you to set the Close LED colour and the Mid-Travel LED being on or off.

OH Close LED Colour

The default close limit position indicator colour is **[9r] Green**.

If red indication is required at the close limit position, press the **+** or **-** key.

The display will change to **[rE] Red**.

PRESS THE  KEY.

The displayed option will flash (stored) indicating that it has been set



Press the **→** key to display: **[OU] Mid-Travel LED**.

OU Mid-Travel LED

The default for mid travel position indicator colour is **[OF] Off**.

If mid-travel LED indication is required, press the **+** or **-** key.

The display will change to **[On] On**.

PRESS THE  KEY.

The displayed option will flash (stored) indicating that it has been set.



Press the **→** key to display: **[UL] Language**.

9.17 Display Language

58

UL Language

The default display text language is English. If the language was specified at time of order the actuator will be despatched with the specified language set.

Press the **+** or **-** keys to view alternative languages.

Available standard languages:

German **Deutsch**

French **Français**

Spanish **Español**

Depending on the specified language, only English and one other may be supplied with the actuator.



9.18 Default Options [d1] and [d2]

All IQT functions are configured to a set of Rotork default (standard) settings before despatch, see the table opposite. When requested, alternative settings specified with the order will be used. When site commissioning takes place, entered settings overwrite Rotork defaults and these "current" settings are used for operation along with the remaining unadjusted defaults.

Should difficulty be encountered during commissioning the default settings can be reinstated, returning the actuator configuration to its original manufactured state. Site commissioning must then begin again.

There are two levels of default:

d1 Rotork standard or customer specified Basic and Configuration Settings.

d2 Limit positions only – factory set limits.

NOTE: Settings associated with control options Folomatic, Pakscan, Modbus Profibus and Foundation Fieldbus are not affected by d1 or d2. Functions will remain as set.

If d1 is entered, all Basic and Configuration Settings except limit positions will return to their default setting. See the table opposite for Rotork standard settings. Basic settings (except limits) and Configuration Settings must then be checked and reset as required (refer to Basic Settings page 17 and Configuration Settings page 27).

If d2 is entered the limits will be reset, with the actuator positioned at 50%. Limits must then be reset to the suit the valve (refer to Basic Settings page 17).

Rotork standard [d1] Default settings for IQT:

Function	[d1] Default Setting
[P?] Password	Unaffected – will remain as set
[Ir] IrDA – Insight	[ON] IrDA Enabled

Basic Settings

[C1] Close Direction	[C] Clockwise
[C2] Close Action	[Ct] Close on Torque
[C3] Open Action	[Ot] Open on Torque
[tC] Close Torque	[40] 40% of rated
[tO] Open Torque	[40] 40% of rated

Configuration Settings

[r1] Indication Contact S1	[CI]/[NO] Close, Normally Open
[r2] Indication Contact S2	[OP]/[NO] Open, Normally Open
[r3] Indication Contact S3	[CI]/[NC] Close, Normally Closed
[r4] Indication Contact S4	[OP]/[NO] Open, Normally Closed
[A1] ESD Action	[SP] Stay put on ESD
[A2] ESD Contact Type	[NO] Normally Open (make for ESD)
[A3] ESD Thermostat Override	[OF] Thermostats Active during ESD
[A4] ESD Override Interlocks	[OF] Interlocks Active during ESD
[A5] ESD Override Local Stop	[OF] Local Stop Active during ESD
[A6] Maintained Local Control	[ON] Maintains in Local Control

9.18 Default Options [d1] and [d2] cont.

Rotork standard [d1] Default settings continued:

Function	[d1]	Default Setting
[A7] 2-wire Remote Control	[SP]	Stay Put on 2-wire signal
[A8] Interlocks	[OF]	I/L function disabled
[A9] Conditional Control	[OF]	Function disabled
[AE] Torque Switch Bypass	[OF]	Function disabled
[OE] Option Extra Indication Contacts	[OF]	Unless fitted. See wiring diagram
[OI] Option CPT	[HI]	4mA at Closed
[Od] Remote Source	[rE]	Unless option fitted (refer to 9.7 page 40.)
[OJ] Option Interrupter Timer	[OF]	Unless fitted. See wiring diagram
[Or] Setting Tool Local Control	[OF]	Setting Tool Control disabled
[OS] Power Loss Inhibit	[OF]	Protection off

Option Extra Indication Contacts (when fitted) - refer to wiring diagram

[r5] Indication Contact S5	[CI]/[NO]	Close, normally open
[r6] Indication Contact S6	[OP]/[NO]	Open, normally open
[r7] Indication Contact S7	[tl]/[NO]	Torque Trip Mid Travel, normally open
[r8] Indication Contact S8	[rE]/[NO]	Remote Selected, normally open

The Rotork standard default settings are subject to change without notice.

If specified with order, [d1] settings will be configured as requested.

To reinstate [d1] settings, with [d1] displayed.

PRESS THE  KEY.

The setting bars will flash, indicating the [d1] default settings have been reinstated.

To reinstate factory set limits (actuator positioned at 50%) with [d2] displayed,

PRESS THE  KEY.

The setting bars will flash, indicating the [d2] default limits have been reinstated.

 **Limits must now be reset. Refer to page 24.**



[d1] Displayed



[d2] Displayed

9.19 Actuator Type Setting

Actuator type determines the speed range and is factory set. Should the actuator Motor Speed Control PCB be replaced with a spare, the actuator type must be set. Failure to set the correct type will invalidate the actuator performance specification and warranty. To set the actuator types go to setting **[Ab]** in the secondary functions.

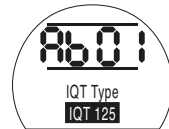
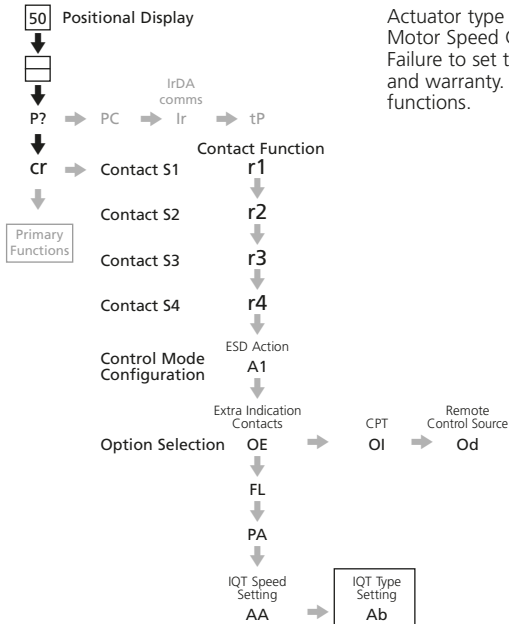

With **[Ab]** displayed

Use the **+** and **-** key to select the required actuator type. The selectable values are related to actuator type as follows:

Value	Type
1	IQT125
3	IQT250
6	IQT500
12	IQT1000
24	IQT2000

PRESS THE  KEY.

The displayed value will flash, indicating that it has been set.

Any value of hex outside of the range stated will not be accepted into the actuator memory.

NOTE: Mains power has to be on for actuator type setting to be carried out.

10.1 Introduction.

The IQT battery failsafe actuator provides electrical operation after loss of main AC electrical supply, allowing the valve to be controlled to a process, mains fail safe position. On loss of AC supply, power is provided from integral batteries located in an extended version of the terminal cover. With AC power applied to the actuator, the batteries are charged from the actuator.



There are three possible failsafe actions that can be customer configured:

Failsafe Close -

Close valve on loss of AC supply

Failsafe Open -

Open valve on loss of AC supply

Stayput waiting for command - The actuator can then be directed to operate via local or standard remote control signals* within 30 minutes of AC power being removed.

*Remote signals must be applied to standard remote control inputs, close on terminal 33, open on terminal 35 or ESD on terminal 3 of battery pack connector. On loss of AC supply remote control via Folomatic proportional control or serial digital network signals are not available.

*On loss of AC supply the IQT battery failsafe does not support customer nominal 24V DC supply on terminals 4 (-ve) and 5 (+ve) and therefore control signal supply must be externally powered. Refer to wiring diagram.

On loss of AC supply the IQT battery failsafe does not support analogue current position transmitter (CPT) position feedback or serial network communication. The IQT monitor relay will de-energise on loss of AC supply.



WARNING: **CONTAINS BATTERIES**

FIRE, EXPLOSION AND SEVERE BURN HAZARD. DO NOT SHORT CIRCUIT. DO NOT INCINERATE.

DO NOT DISASSEMBLE BATTERY PACK. RECHARGE ONLY AS PART OF THE IQT. DO NOT EXPOSE BATTERIES TO AMBIENT TEMPERATURES ABOVE 60°C

THE IQT BATTERY FAILSAFE ACTUATOR CONTAINS HIGH CAPACITY BATTERIES WHICH ARE CONNECTED TO ACTUATOR TERMINALS 14 (+) AND 21 (-). DC BATTERY POWER MAY BE SUPPLIED TO THESE TERMINALS WHEN THE AC ELECTRICAL SUPPLY IS SWITCHED ON AND SWITCHED OFF.

For safety the IQT Failsafe battery pack is shipped with DC power fuses FS3 and FS4 removed. It is essential that the fuses are removed before any maintenance work is carried out on the actuator or the battery assembly.

Before fitting Fuses FS3 and FS4 the IQT actuator must be commissioned in accordance with section 7, page 11 of this manual.

10.2 Battery Failsafe Specification

Environmental:

Operating temperature -30°C to + 60°C.

Enclosure (IQT battery Failsafe actuator):
Watertight IP68 — 7m / 72 Hrs.

Battery Pack:

Type: Sealed lead–acid batteries located in a vented enclosure.

Voltage & Capacity: 28V — 2.5Ah.

Float life: 8 Years at 20°C, 3 years at 40° C.

Storage Life: 2 years at 23°C, 2 months at 60° C.

Battery pack assembly weight: 5.5Kg.
For total IQT battery failsafe weight, add 5.5Kg to the actuator weights listed on page 80.

Charger :

The IQT battery failsafe is despatched with the batteries in a charged state, however once the IQT is connected to AC power the batteries will automatically begin charging to bring them to the float charge state. For correct battery charging, the IQT supply voltage must not be less than 90% of nominal.

Charging Time — typically 4 hours from a discharged state (depending on ambient temperature).

Charge state — The lower line of text will display the state of the battery, see fig.2.

On loss of AC power, the state of the battery is not displayed.

DC power supply — Fuses FS 3 and FS4 are rated at 20A, automobile type ATO Fast acting.

Charge/control — Fuses FS1 and FS2 are rated 2A, 20mm quick blow.

The battery supply will auto disconnect at 20V or 30 minutes after AC supply is removed from the actuator to prevent damage caused by deep discharge of batteries.

Maintenance :

Ensure the two vents located in the battery pack cover are not removed, plugged or covered. The batteries are sealed lead acid type and require no maintenance. Refer to section 11, page 67 for IQT range maintenance.

Failsafe Operation Performance:

Number of operations at 75% rated torque.

Temperature °C	IQT125	IQT250	IQT500	IQT1000	IQT2000
-30	15	12	6	3	1
-20	50	40	20	10	5
-0	63	50	25	12	6
20	75	60	30	15	7
40	75	60	30	15	7
60	75	60	30	15	7



Fig. 1

IQT Battery Failsafe Actuator Display

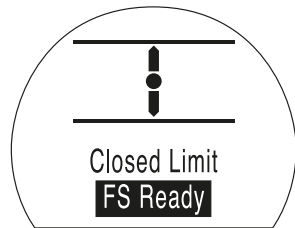

FS Ready
FS Boost Charge
FS Charging

Fig. 2

10.3 Failsafe Commissioning Instructions

⚠ Before commissioning the failsafe operation it is essential that the IQT actuator has first been commissioned in accordance with the Installation and Commissioning Instructions in this manual.

1. Remove Cover. Figure 3

Ensure the AC power supply to the actuator is switched OFF.

Using a 6mm allen key remove the four screws securing the IQT battery failsafe cover and remove cover from actuator housing. The cover houses the battery pack and charging/control circuitry and care must be taken that it does not drop.

Ensure the two 20A fuses located in a plastic bag are kept safely - DO NOT FIT

The cover is restrained with an external chain to support its weight (5.5 Kg approx) and prevent interconnecting cables being damaged. The battery failsafe cover assembly is supported by the restraining chain during commissioning.

2. Set Control Links. Figure 4

Referring to the label, locate PCB links LK1 and LK2. Links determine required action on loss of AC supply to the actuator.

Using pliers, fit links LK1 and LK2 in required positions.

Links bridge between pins 1-2 or 2-3 and must be set for the desired action as detailed in table the below:

***The direction required for failsafe operation and ESD contact form (if being used) is set with the IQT setting tool. Refer to page 66 of this manual.**

LK1	LK2	Required action
1-2	1-2	Failsafe on loss of supply, ESD [A2] set [NO]*
2-3	1-2	Failsafe on loss of supply, ESD [A2] set [NC]*
1-2	2-3	Stayput waiting for command (30 Min max)

3. Connect ESD/Interlock control wiring. Figure 5

If the control of the IQT actuator with AC supply switched ON requires emergency shut down and/or interlocks, ESD and/or interlock field wiring must be connected to the green terminal plug located on the battery pack assembly.

If ESD and/or interlocks do not form part of the IQT control scheme then no wiring is necessary.

Remove plug by pulling it straight up and connect field wiring for ESD and/or interlocks as indicated on the label and actuator wiring diagram.

Once connected, re-fit the wired plug into its socket. The plug and socket are polarised, ensuring they cannot be mated incorrectly.

4. Fit Battery Fuses. Figure 6

Referring to the label, locate 20A fuses FS3 and FS4 holders located on the battery pack assembly.

Remove 20A fuses from the plastic bag and fit into fuse holders FS3 and FS4 as shown.

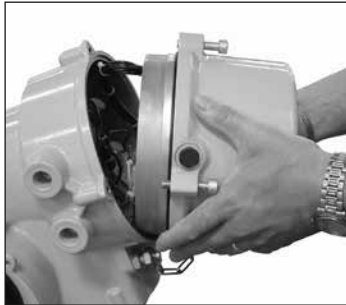

Fig. 3

5. Refit Cover. Figure 7

Make sure cover O-ring is fitted and the cover spigot is lightly greased.

Refit cover making sure no field or interconnecting wires are trapped between cover and gearcase.

Tighten the 4 fixing bolts using a 6mm allen key.

Set up of the battery pack is now complete.

To enable failsafe operation, settings within the IQT actuator must now be made.

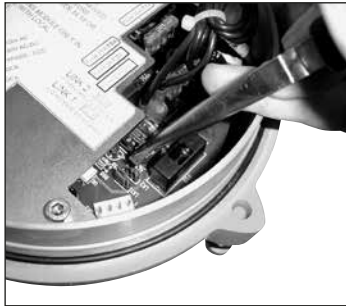

Fig. 4



Fig. 5

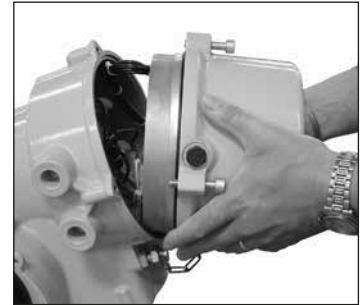

Fig. 7

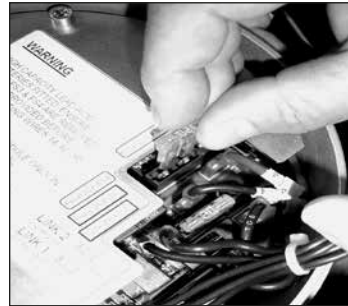

Fig. 6

6. IQT Actuator Failsafe Settings.

The actuator can be operated by standard remote control signals (open/close/interlocks/ESD) under AC supply control.

On AC supply loss, the actuator will automatically perform an ESD using battery power.

For the required failsafe operation, using the supplied Infra-red Setting Tool, set configuration functions [A1], [A2] and [A4] for the desired failsafe action. Refer to page 32, [A1] ESD Action, [A2] ESD contact type and [A4] ESD override interlocks actuator settings must be checked and/or set .

Switch ON AC supply power to the IQT actuator. Refer to table below for settings.

NOTE. If network option cards are used with a failsafe setup the auxillary input masks [PF] must be set accordingly. The ESD setting in the mask must always be set for NO (normally open) type. For example if only the ESD is required for an auxillary input, the setting would be 80 (hex). See section 9 configuration settings. Ensure the remote control source option [Od] is set to [oP].

Failsafe action on loss of AC supply	LK1*	LK2*	[A1]	[A2]	[A4]
Close (no user ESD)	1-2	1-2	[CL]	[NO]	[OF]
Open (no user ESD)	1-2	1-2	[OP]	[NO]	[OF]
Close ESD = N/O contact, "makes" for ESD	1-2	1-2	[CL]	[NO]	[OF]
Open ESD = N/O contact, "makes" for ESD	1-2	1-2	[OP]	[NO]	[OF]
Close ESD = N/C contact, "breaks" for ESD	2-3	1-2	[CL]	[NC]	[OF]
Open ESD = N/C contact, "breaks" for ESD	2-3	1-2	[OP]	[NC]	[OF]

NOTE. If ESD is being used for AC supply control the user must decide if ESD is to override local stop. If ESD override local stop is required set [A5] to [NO].

Testing

To test the failsafe function, switch off AC supply to IQT actuator. Actuator will perform the set failsafe function.

Refer to page 63.

11 Maintenance, Monitoring and Troubleshooting

Maintenance

Every Rotork actuator has been fully tested before dispatch to give years of trouble-free operation providing it is installed, sealed and commissioned in accordance with the instructions given in this publication.

The IQT actuator's unique double sealed, non-intrusive enclosure provides complete protection for the actuator components.

Covers should not be removed for routine inspection as this may be detrimental to the future reliability of the actuator.

The electrical control module cover is bonded by the Rotork quality control seal. It should not be removed as the module contains no site-serviceable components.

All electrical power supplies to the actuator must be isolated before any maintenance or inspection is carried out, except replacement of the battery.

Electrical supplies must be isolated before actuator covers are removed refer to Battery replacement instructions.

Routine maintenance should include the following:

- * Check actuator to valve fixing bolts for tightness.
- * Ensure valve stems and drive nuts are clean and properly lubricated.
- * If the motorised valve is rarely operated, a routine operating schedule should be set up.
- * Replace actuator battery every 5 years.
- * Check the actuator enclosure for damage, loose or missing fasteners.
- * Ensure there is not an excessive build up of dust or contaminant on the actuator.
- * Check for any loss of lubricant.

The Actuator Battery

The battery supports the actuator position updating circuits and the position (LCD) display when the main power supply is turned off. It ensures the current position is updated and displayed when manual operation takes place with the main power turned off.

The battery is not required to retain any actuator settings.

⚠ WARNING:
The battery holder in the actuator gearcase also protects the user from the hazardous live connections inside the actuator and therefore it must not be damaged. The actuator must be isolated or disconnected if the battery holder has to be removed from the actuator gearcase.

A unique circuit has been incorporated into the battery function of the IQT, effectively reducing the overall drain and significantly increasing the battery life.

⚠ In normal circumstances battery replacement interval should not exceed 5 years. Ambient temperature and plant operating conditions may affect battery life.

Battery level status is indicated by an icon on the actuator display, refer to Section 3.4 Alarm Indication (*refer to page 5*).

If the battery icon is displayed the battery must be replaced.

Battery Replacement

If the actuator is located within a hazardous area permission must be obtained in the form of a "hot work permit" or other local regulation before removal and/or replacement of the battery.

⚠ WARNING:
48 VDC supply only - Actuator power supply must be isolated before replacing the backup 9V PP3 battery. For all other supplies the power can remain switched on.

NOTE: Removal of the battery with the mains electrical power switched off will result in stored Datalogger record time references being lost for the duration when there is no mains supply or battery power. Therefore for all supplies other than 48 VDC, leaving the power supply switched on is recommended.

If main electrical power is not available or if main power has been switched off while the battery was discharged, it is recommended that the actuator limits be checked after battery replacement (*refer to Section 8 Commissioning Basic Settings, page 17*).

11 Maintenance, Monitoring and Troubleshooting cont.

Battery Removal

The actuator must be selected to Stop using the red selector (*refer to page 3*). Access to the battery is via a labelled sealing plug situated on the main gearcase near the handwheel hub.

Remove the sealing plug using the appropriate Allen key, ensuring the "O" ring seal remains on the plug. Disconnect the battery wiring loom from the battery terminals. Using the black pull strap, lift the battery out of the rubber sealing pocket.



Fig. 11.1

Battery Types

For European hazardous area certified actuators (ATEX) use an Ultralife U9VL lithium manganese dioxide battery only.

For FM and CSA certified enclosures use an Ultralife U9VL lithium manganese dioxide battery. Equivalent, UL recognised, batteries may be used.

For watertight (WT) actuator enclosures use an Ultralife U9VL lithium manganese dioxide battery or any equivalent 9V battery.

If in doubt regarding the correct battery type, contact Rotork.

Fitting Replacement Battery

Fit the pull strap around the replacement battery and insert into the rubber sealing pocket. Reconnect the battery wiring loom to the battery terminals. Refit the battery sealing plug ensuring "O" ring is in good condition and correctly fitted. Hand tighten the sealing plug to 8 Nm (6 lbs.ft) using the appropriate Allen key.

Torque and Position Monitoring

The IQT range of actuators incorporate real time, instantaneous Torque & Position monitoring as standard.

Torque & Position can be used to monitor valve performance during operation. The effect of process changes (differential pressure etc.) can be evaluated. Tight spots in valve travel can be pinpointed as well as gauging torque developed through stroke for torque value setting (*refer to pages 22, 23*).

Using the Setting Tool, the display can be set to indicate Torque and Position as follows:

With the actuator displaying Current Position, using the Setting Tool,

PRESS THE ↓ KEY.

The lower display will show the torque value as a percentage and a graphical representation in the form of a bar graph.

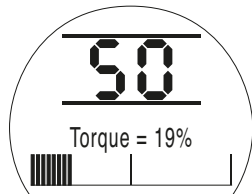

Example shows 19% (of rated) torque at 50% open position. Display torque range: [00] to [99] % of rated torque in 1% increments. For values of torque above 99% the display will indicate [HI].

Display position range:

[] []	= valve closed
[00] to [99]	= percentage open
[≡≡]	= valve open

For a stationary actuator the display will indicate the actual torque value as applied by the actuator.

To keep the torque & position display active press the + or - keys. The display will remain active for approximately 5 minutes from the last key operation.

11 Maintenance, Monitoring and Troubleshooting cont.

Torque – Reference Profile

IQT text display models only.

Only visible when in Setting Mode. See Section 7, page 15.

This feature allows the user to store a reference torque profile, which can be used to plan and determine periodic maintenance.

After commissioning has taken place and the process is running under normal conditions, a profile of the “as commissioned” torque measurement over the whole stroke can be taken and stored in the Datalogger. The stored torque reference profile can be compared with later torque profiles using Rotork Insight in order to determine changes in performance of the valve and/or process over time or under different conditions.

Storing a Reference Profile

The location of torque reference profile [tP] screen is shown below:

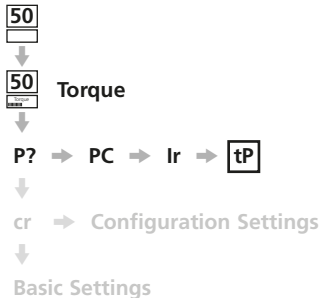

Each actuator is supplied without a reference profile stored. To store a reference profile, electrically stroke the actuator under normal process conditions.

Once the reference stroke (close to open / open to close) is complete stop the actuator.

Using the supplied Setting Tool, press the ↓ arrow key twice to display the password screen. Refer to section 7 page 15.

Enter the correct password and press the ← key, “Password Correct” should display briefly and the setting bars appear.

Press the → arrow key 3 times to display the [tP] screen:



Pressing the ← key stores the last measured “reference” close-open and open-close torque profiles within the datalogger.

Press the → and ↓ keys together to return to the positional display.

The reference profile along with current profiles can be viewed and analysed using IQ Insight software as shown in Fig 11.2.

IQ Insight is available free, visit www.rotork.com

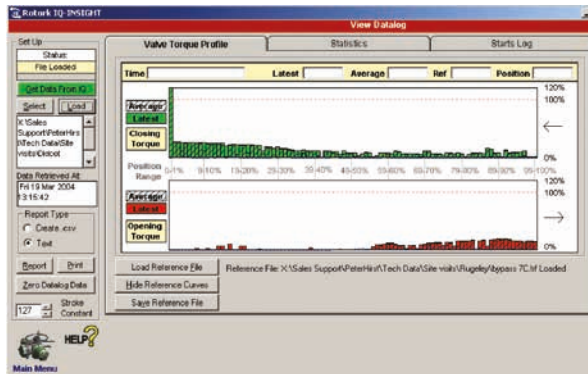

Fig. 11.2

11 Maintenance, Monitoring and Troubleshooting cont.

Troubleshooting

The IQT range of actuators is the world's first that can be commissioned and interrogated without removing electrical covers. Help Screen diagnostics enable fast and complete fault finding to be carried out.

Question: With power on, the actuator display is not backlit. Position indicator lamp not illuminated. What is wrong?

Answer: With mains power on, the actuator's display should be backlit (refer to Section 3.3 page 4 – The Actuator Display).

Check that 3 phase supply is available and is of the correct voltage as stated on the actuator nameplate. Measure voltage phase to phase across terminals 1, 2 and 3 of the actuator terminal bung.

Question: With power off, the actuator does not display position. What is wrong?

Answer: With mains power off the actuator battery supports position indication liquid crystal display only.

(Refer to Section 3.3 page 4 – The Actuator Display).

If the display is blank the actuator battery must be replaced and the limits of travel reset (refer to Section 11, page 67 – The Actuator Battery).

11.1 Setting Tool Pro Download & Upload

Setting Tool Pro Download & Upload

Setting Tool Pro includes a feature which allows the user to extract and store IQT actuator configuration and datalogger files within the Tool. Stored files can be viewed using a PC running IQ Insight ©. Using This tool, stored configuration files can also be uploaded back to IQT actuators in order to replicate a setup for multiple units (limits must be set individually).

IQ Insight is available free from www.rotork.com

Using the new features

Datalogger and configuration files can be extracted and stored in the Tool without entering a password. For uploading configuration files from Tool to actuator, the actuator's password must first be entered correctly – see section 7, page 15 for details.

Accessing the menus

The download/upload menus are accessed when the Setting Tool Pro download key  is pressed. IrDA communication is initialised, the green LED in the tool window will flash. The user then has 30 seconds to “connect” to the actuator.

Download/Upload Menu structure

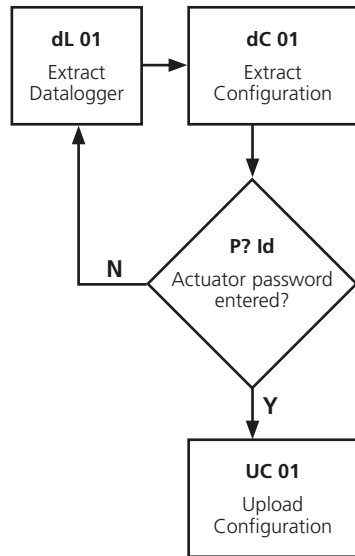

11.1 Setting Tool Pro Download & Upload cont.

Downloading and storing IQT Datalogger Files

Press the  Key

The green LED visible in the setting Tool window will start flashing.

Point the Tool at the actuator Display

Once communication has been successfully established, the Extract Datalogger screen will be displayed:



Extract Datalogger screen

Note. IQT actuators with non text displays show code/symbols only.

The screen will default to Memory Location 01. There are a total of four memory locations available for dataloggers, which are selected by pressing the + or – keys.

When the required location has been selected, press the  key to initiate the extraction. The following screen will be displayed:



Extracting Log screen

Note. IQT actuators with non text displays show code/symbols only.

The extraction takes approximately 35 seconds for a full datalogger (2 minutes for non text displays). After a successful extraction, the screen will revert to the Extract Log screen. If during the downloading an error is encountered, [dL Er] will be displayed along with **Error**, wait for the screen to revert to [dl 01] and try again.

The action of downloading the actuator datalogger file will automatically download the configuration file to the Tool.

Downloading and storing IQT Configuration Files

Press the  Key

The green LED visible in the setting Tool window will start flashing.

Point the Tool at the actuator Display

Once communication has been successfully established, the Extract Datalogger screen will be displayed:



Extract Datalogger screen

Note. IQT actuators with non text displays show code/symbols only.

PRESS THE  KEY.

The following screen will be displayed:



Extract Configuration screen

Note. IQT actuators with non text displays show code/symbols only.

The screen will default to Memory Location 01. There are a total of ten memory locations available for Configuration Files, which are selected by pressing the + or – keys.

When the required location has been selected, press the  key to initiate the extraction. The following screen will be displayed:



Extracting Configuration screen

Note. IQT actuators with non text displays show code/symbols only.

The extraction takes approximately 3 seconds. After a successful extraction, the screen will revert to the Extract configuration screen. If during the downloading an error is encountered, [dC Er] will be displayed along with **Error**, wait for 5 seconds until the screen reverts to [dc 01] and try again.

11.1 Setting Tool Pro Download & Upload cont.

Uploading a configuration File to an IQT actuator

⚠ Note: Actuator must be set to Local when writing configuration data.

⚠ Warning: After uploading a configuration file from the tool to the actuator, the actuator basic and configuration set up will be a duplicate of the file set up.
Refer to sections 8 & 9.

Open and close limit positions and current position are not copied and must be set on each individual actuator. Refer to section 8.

For access to the Upload Configuration screen, the actuators password must first be set correctly, see section 7.

Press the  Key

The green LED visible in the setting Tool window will start flashing.

Point the Tool at the actuator Display

Once communication has been successfully established, the download datalogger screen will be displayed.**[dL 01]**

PRESS THE  KEY.

The download configuration screen will be displayed: **[dC 01]**

PRESS THE  KEY.

The upload configuration screen will be displayed:



Upload Configuration screen

Note. IQT actuators with non text displays show code/symbols only.

Using the + or – keys, select the memory location where the required configuration file is stored and press the  key, the following screen will be displayed:



Uploading Configuration screen

Note. IQT actuators with non text displays show code/symbols only.

The writing process take approximately 12 seconds to complete, after which the screen reverts to the Uploading Configuration screen. If during the writing process an error is encountered, **[UC Er]** will be displayed along with **Error**, wait for 5 seconds until the screen reverts to **[UC 01]** and try again.

11.2 Help Screens

With the actuator powered up and Local or Stop selected, eight Help Screens can be accessed using the Setting Tool (refer to Fig. 9.1 page 29 for their location).

With Remote selected press the ↓ key on the Setting Tool twice. The Help Screens will be displayed.

Each screen uses bars to indicate the status of a particular control or indication function. Each bar reacts to changes in the status of its actuator function by turning "on" or "off".

For troubleshooting, access the following Help Screens and refer to text:

- H1** – Factors inhibiting electrical operation.
- H2** – Monitor battery level and ESD control input.
- H3** – Monitor the position limit and actuator power supply status.
- H4** – Monitor remote control inputs to the actuator.
- H5** – Monitor remote interlocks local control inputs and motor thermostats.
- H6** – Monitor torque switch status and IR Setting Tool communication for vandal proof applications.
- H7** – Monitor travel limits, centre column and position limit status.
- H8** – Monitor the actuator's position-sensing devices.
- H9** – Rotork use only.

Help screen bars shown  are undefined and may be ON, OFF or flashing.

H1 Factors Inhibiting Electrical Operation

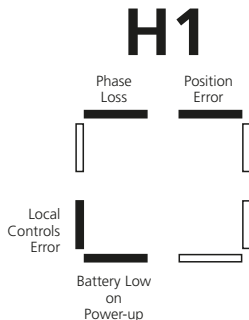

Help Screen 1

POSITION ERROR Bar ON = Current Position Error Present.

During power up the actuator position processor compares the current position to that stored in the Eeprom. If there is a discrepancy this is shown as a current position error.

Re-setting of both actuator limits should now be carried out (refer to page 24).

BATTERY LOW ON POWER UP Bar ON = Low battery detected On Power Up.

If [OS] is selected [ON] (default is [OF]) the actuator operation will be inhibited when powered up with a discharged battery (refer to [OS] page 57).

The battery should be replaced at the earliest opportunity (refer to page 67).

LOCAL CONTROLS ERROR Bar ON = Invalid Local Control Signals Detected.

For example if a Local Open and Close signal is detected at the same time this would be classed as an invalid or fault condition.

PHASE LOSS Bar ON = Phase Lost (3 Phase Actuators Only).

Loss of third monitored power supply phase connected to actuator terminal 3.

H2 Battery Level and ESD Control Input

H2

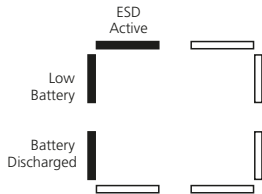

Help Screen 2

BATTERY DISCHARGED Bar ON = Battery Discharged.

Bar ON when the battery is no longer able to support actuator functions under loss of power conditions.

The battery must be replaced (*refer to Section 11 page 67*) and limit positions reset (*refer to [LC] and [LO] page 24*).

LOW BATTERY Bar ON = Battery level low. Bar OFF = Battery OK.

Bar ON when the battery is low but still able to support the necessary actuator functions.

The battery should be replaced at the earliest possible opportunity.

ESD SIGNAL ACTIVE Bar ON = ESD Signal is present.

When applied, an Emergency Shutdown Signal will override any existing local or remote control signal, causing the actuator to respond in the direction selected for ESD.

The ESD function will be determined by the settings on Control Mode Configuration screens [A1] to [A5] (*refer to Section 9.3 page 32*).

The actuator will not respond to any local or remote control while an ESD signal is maintained.

H3 Factors Inhibiting Electrical Operation

H3

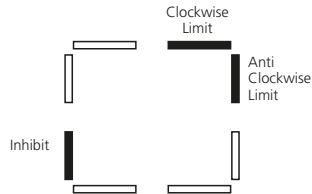

Help Screen 3

CLOCKWISE LIMIT Bar ON = Actuator has reached clockwise limit of travel.

ANTI-CLOCKWISE LIMIT Bar ON = Actuator has reached Anti-clockwise limit.

INHIBIT Bar ON = Actuator inhibited.

Possible Causes:

Phase Loss (3 phase only).
Power Loss Inhibit (page 57).
Internal Failure.

H4 Remote Control Inputs

H4

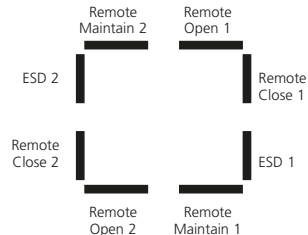

Help Screen 4

All remote signals designated with '1' are standard hard wired remote inputs.

When a Pakscan, Profibus or Foundation Fieldbus card is fitted, remote control inputs are designated with a '2'.

REMOTE OPEN 1 Bar OFF = Remote Open Signal Present.

continued...

H4 Remote Control Inputs continued

REMOTE CLOSE 1

Bar OFF = Remote Close Signal Present.

ESD 1

Bar OFF = ESD signal present.

REMOTE MAINTAIN 1

Bar OFF = Remote Maintain signal present.

Bar ON = Remote Maintain not present and/or Remote Stop active.

REMOTE OPEN 2

Bar OFF = Remote Open signal present from BUS option pcb.

REMOTE CLOSE 2

Bar OFF = Remote Close signal present from BUS option pcb.

ESD 2

Bar OFF = ESD signal present from BUS option pcb.

REMOTE MAINTAIN 2

Bar OFF = Remote Maintain signal present from BUS option pcb.

H5 Remote Interlocks, Local Control Inputs, & T/stat

H5

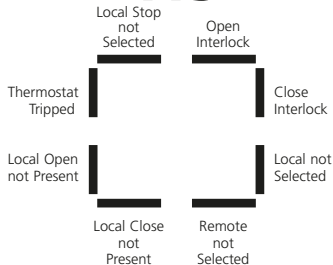

Help Screen 5

OPEN INTERLOCK

Bar ON = Open Interlock Active.
(Actuator disabled)

Unauthorised Open electrical operation can be prevented by interlocking the actuator (Open) control with an external interlock contact.

If external interlocks are not required the interlock function must be selected OFF.

CLOSE INTERLOCK

Bar ON = Close Interlock Active.
(Actuator disabled)

Unauthorised Close electrical operation can be prevented by interlocking the actuator (Close) control with an external interlock contact.

If external interlocks are not required the interlock function must be selected OFF.

REMOTE NOT SELECTED

Bar ON = Remote control not selected.
Bar OFF = Remote control selected.

LOCAL CLOSE NOT PRESENT

Bar ON = Local Close signal not present.
Bar OFF = Local Close signal present.

LOCAL OPEN NOT PRESENT

Bar ON = Local Open signal not present.
Bar OFF = Local Open signal present.

THERMOSTAT TRIPPED

Bar ON = Thermostat tripped.

The actuator motor is protected by thermostats.

Should the motor become overheated the thermostats will trip and the actuator will stop. On cooling the thermostat will automatically reset, enabling operation. See the actuator nameplate for the motor rating.

LOCAL STOP NOT SELECTED

Bar ON = Local Stop not selected.
Bar OFF = Local stop selected.

LOCAL NOT SELECTED

Bar ON = Local control not selected.
Bar OFF = Local control selected.

H6

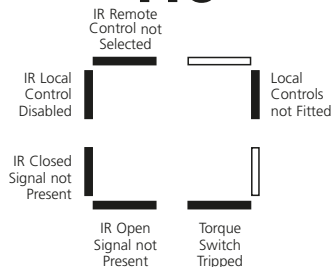

Help Screen 6

When actuators are supplied for Vandal Proof applications the local control knobs are removed to prevent unauthorised operation.

The local control functions are then carried out by using the Infra-red Setting Tool.

LOCAL CONTROLS NOT FITTED

Bar OFF = Local controls fitted (standard).

Bar ON = Local controls not fitted (vandal proof).

TORQUE SWITCH TRIPPED

Bar ON = Torque switch tripped.

When the actuator generates a value of torque equal to that set for Open (when opening) or Close (when closing) it will stop, protecting itself and the valve from damage. This feature is known as Over Torque Protection.

Once a torque trip has occurred further operation **IN THE SAME DIRECTION** is prevented.

This “latching” of the event protects the actuator and valve from repeated “hammering” against the obstruction as a response to a maintained control signal.

To “de-latch” the actuator it must be reversed.

(For actuator torque adjustment, refer to [tC] and [tO] pages 22 and 23)

IR OPEN SIGNAL NOT PRESENT

Bar OFF = IR Open signal present.

IR CLOSE SIGNAL NOT PRESENT

Bar OFF = IR Close signal present.

IR LOCAL CONTROL DISABLED

Bar OFF = IR Local control enabled.

To operate the actuator locally with the IR Setting Tool refer to the option selection screen [OR] Section 9.14, page 57.

[OR] must be selected to [ON].

IR REMOTE CONTROL NOT SELECTED

Bar OFF = IR Remote control selected (vandal-proof units only).

When actuator is supplied without local controls for vandal proof applications the option selection screen [OR] must be set to [RE] for Remote operation (refer to Section 9.14 page 57).

H7

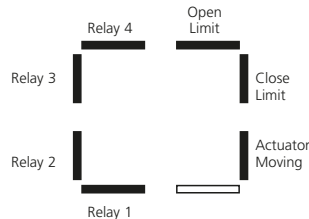

Help Screen 7

OPEN LIMIT

Bar ON = Actuator has reached open limit.

CLOSE LIMIT

Bar ON = Actuator has reached Close limit.

ACTUATOR MOVING

Bar ON = Actuator moving.

SWITCH CONTACTS S1, S2, S3, S4

Bar ON = S contact is close circuit.

Bar indication is real time and reactive (refer to Section 9.2 [r1] page 30 for configuration of “S”contacts).

H8

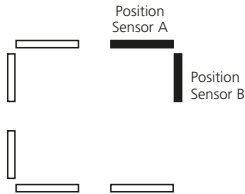

Help Screen 8

POSITION SENSOR A

Senses output rotation. Used for the position sensing circuit. Correct operation of the sensor is indicated by the bar being ON (and OFF) 12 times per output revolution. When the motor is running, ON and OFF bit duration should be equal.

POSITION SENSOR B

Senses output rotation. Used for the position sensing circuit. Correct operation of the sensor is indicated by the bar being ON (and OFF) 12 times per output revolution.

When the motor is running, ON and OFF bit duration should be equal.

For the two sensors, A and B, correct operation is indicated by the following truth table.

To observe this function, select manual operation and turn the actuator handwheel clockwise, starting with all sensors OFF:

CLOCKWISE 30 Deg.



Sensor B	0	1	1	0	0
Sensor A	0	0	1	1	0

11.3 IQT Infrared Diagnostic and Configuration

IQT actuators include an IrDA® (Infrared Data Association) interface as standard, allowing non-intrusive diagnostics, analysis and configuration.

IQ Insight software tool for PC and IQ Pocket Insight for PDA (Personal Digital Assistant) have been developed to enable the actuator configuration and onboard datalogger to be reconfigured and analysed. A PC running IQ Insight software or PDA running IQ Pocket Insight can be used to interrogate the actuator via non-intrusive infra red IrDA communication. Visit www.rotork.com for information.

Alternatively, the intrinsically safe Rotork Setting Tool *Pro* allows the user to extract and store IQT actuator configuration and datalogger files within the Tool. Stored files can be uploaded over an IrDA –USB interface to a PC running Rotork IQ Insight where they can be viewed, analysed and stored in a safe, clean environment.

Using the Setting Tool *Pro*, actuator set up can be configured on the PC, stored in the tool, transported to the actuator and uploaded. The tool can transfer the same configuration to multiple actuators where actuator setup is the same. Refer to page 70.

To enable communication with IQ Insight the actuator IrDA interface must be enabled.

The default setting for IQT IrDA is **[On]**, enabling IrDA.

To disable IrDA and prevent IrDA access, use the **+** or **-** key. The display will change to **[OF]**.

PRESS THE  KEY.

The displayed option will flash (stored) indicating it has been set.



IQ Insight and IQ Pocket Insight software are available free of charge from the Rotork web site, www.rotork.com.

A kit is available from Rotork, which includes an IrDA-USB adapter and drivers for connection to a PC. The Kit also includes IQ Insight software. PDA communication is via the internal IrDA port.

 **The use of a notebook PC or PDA with actuators located in hazardous areas will be subject to local regulations. It is the responsibility of the user to seek guidance and permission.**

The Rotork Setting Tool and Setting Tool *Pro* are certified Intrinsically Safe (IS) and therefore can be used in defined hazardous areas (refer to page 12 and 13).

End user advice on disposal at end of life of the product

Subject	Definition	Remarks / examples	Hazardous	Recyclable	EU Waste Code	Disposal
Batteries	Lithium Alkaline Lead Acid	IQ/IQT standby battery Setting tool Battery Failsafe Units	Yes Yes Yes	Yes Yes Yes	16 06 06 16 06 04 16 06 01	Will require special treatment before disposal, use specialist recyclers or waste disposal companies
Electrical & Electronic Equipment	Printed circuit boards Wire	All Products All Products	Yes Yes	Yes Yes	20 01 35 17 04 10	Use specialist recyclers
Glass	Lens/Window	Cenelec Qualified IQ/IQT. A Range Prism	No	Yes	16 01 20	Use specialist recyclers
Metals	Aluminium Copper/Brass Zinc Iron/Steel Mixed Metals	Gearcases and covers most products Wire, IQ columns (not all sizes), motor windings IQ clutch Ring and associated components Gears and Gearcases (A Range and larger IQ) IQ motor rotors	No No No No No	Yes Yes Yes Yes Yes	17 04 02 17 04 01 17 04 04 17 04 05 17 04 07	Use licensed recyclers
Plastics	Glass filled nylon Unfilled	Covers, IQT clutch components, electronics chassis Gears	No No	No Yes	17 02 04 17 02 03	Disposal as general commercial waste Use specialist recyclers
Oil	Mineral & Kerosene Mixed Mineral Food Grade	Gearbox lubrication Gearbox lubrication Gearbox lubrication	Yes Yes Yes	Yes Yes Yes	13 07 03 13 02 04 13 02 08	Will require special treatment before disposal, use specialist recyclers or waste disposal companies
Rubber	Seals & Orings	Cover and shaft sealing	Yes	No	16 01 99	May require special treatment before disposal, use specialist waste disposal companies

In all cases check local authority regulation before disposal.



WARNING: The battery pack contains high capacity lead acid batteries which may have retained their charge. Only persons competent by virtue of their training or experience should remove these items. For recommended procedures please contact Rotork. (see page 84).

Oil

The IQT range are factory filled with 80% Texaco Texamatic 9330 automatic transmission fluid (ATF) and 20% Kerosene. Equivalent ATF lubricants meeting the Dexron® 2 or Mercon® specification may be used. For operating ambient temperatures below -30°C / -22°F (Low temperature option actuators) Texaco 9330 + 80% BP SHF LT15 should be used.

Food grade lubricating oil is available as an alternative: contact Rotork.

Actuator Size	Nett Weight kg/lbs	Oil Capacity litres/pt.-US
IQT 125	23/51	0.5/1.1
IQT 250	23/51	0.5/1.1
IQT 500	23/51	0.5/1.1
IQT 1000	37/82	0.75/1.6
IQT 2000	37/82	0.75/1.6

BHD Binary, Hexadecimal and Decimal Conversion Table

BINARY	HEX	DEC
0000 0000	00	0
0000 0001	01	1
0000 0010	02	2
0000 0011	03	3
0000 0100	04	4
0000 0101	05	5
0000 0110	06	6
0000 0111	07	7
0000 1000	08	8
0000 1001	09	9
0000 1010	0A	10
0000 1011	0B	11
0000 1100	0C	12
0000 1101	0D	13
0000 1110	0E	14
0000 1111	0F	15
0001 0000	10	16
0001 0001	11	17
0001 0010	12	18
0001 0011	13	19
0001 0100	14	20
0001 0101	15	21
0001 0110	16	22
0001 0111	17	23
0001 1000	18	24
0001 1001	19	25
0001 1010	1A	26
0001 1011	1B	27
0001 1100	1C	28
0001 1101	1D	29
0001 1110	1E	30
0001 1111	1F	31

BINARY	HEX	DEC
0010 0000	20	32
0010 0001	21	33
0010 0010	22	34
0010 0011	23	35
0010 0100	24	36
0010 0101	25	37
0010 0110	26	38
0010 0111	27	39
0010 1000	28	40
0010 1001	29	41
0010 1010	2A	42
0010 1011	2B	43
0010 1100	2C	44
0010 1101	2D	45
0010 1110	2E	46
0010 1111	2F	47
0011 0000	30	48
0011 0001	31	49
0011 0010	32	50
0011 0011	33	51
0011 0100	34	52
0011 0101	35	53
0011 0110	36	54
0011 0111	37	55
0011 1000	38	56
0011 1001	39	57
0011 1010	3A	58
0011 1011	3B	59
0011 1100	3C	60
0011 1101	3D	61
0011 1110	3E	62
0011 1111	3F	63

BINARY	HEX	DEC
0100 0000	40	64
0100 0001	41	65
0100 0010	42	66
0100 0011	43	67
0100 0100	44	68
0100 0101	45	69
0100 0110	46	70
0100 0111	47	71
0100 1000	48	72
0100 1001	49	73
0100 1010	4A	74
0100 1011	4B	75
0100 1100	4C	76
0100 1101	4D	77
0100 1110	4E	78
0100 1111	4F	79
0101 0000	50	80
0101 0001	51	81
0101 0010	52	82
0101 0011	53	83
0101 0100	54	84
0101 0101	55	85
0101 0110	56	86
0101 0111	57	87
0101 1000	58	88
0101 1001	59	89
0101 1010	5A	90
0101 1011	5B	91
0101 1100	5C	92
0101 1101	5D	93
0101 1110	5E	94
0101 1111	5F	95

BINARY	HEX	DEC
0110 0000	60	96
0110 0001	61	97
0110 0010	62	98
0110 0011	63	99
0110 0100	64	100
0110 0101	65	101
0110 0110	66	102
0110 0111	67	103
0110 1000	68	104
0110 1001	69	105
0110 1010	6A	106
0110 1011	6B	107
0110 1100	6C	108
0110 1101	6D	109
0110 1110	6E	110
0110 1111	6F	111
0111 0000	70	112
0111 0001	71	113
0111 0010	72	114
0111 0011	73	115
0111 0100	74	116
0111 0101	75	117
0111 0110	76	118
0111 0111	77	119
0111 1000	78	120
0111 1001	79	121
0111 1010	7A	122
0111 1011	7B	123
0111 1100	7C	124
0111 1101	7D	125
0111 1110	7E	126
0111 1111	7F	127

BINARY	HEX	DEC
1000 0000	80	128
1000 0001	81	129
1000 0010	82	130
1000 0011	83	131
1000 0100	84	132
1000 0101	85	133
1000 0110	86	134
1000 0111	87	135
1000 1000	88	136
1000 1001	89	137
1000 1010	8A	138
1000 1011	8B	139
1000 1100	8C	140
1000 1101	8D	141
1000 1110	8E	142
1000 1111	8F	143
1001 0000	90	144
1001 0001	91	145
1001 0010	92	146
1001 0011	93	147
1001 0100	94	148
1001 0101	95	149
1001 0110	96	150
1001 0111	97	151
1001 1000	98	152
1001 1001	99	153
1001 1010	9A	154
1001 1011	9B	155
1001 1100	9C	156
1001 1101	9D	157
1001 1110	9E	158
1001 1111	9F	159

BINARY	HEX	DEC
1010 0000	A0	160
1010 0001	A1	161
1010 0010	A2	162
1010 0011	A3	163
1010 0100	A4	164
1010 0101	A5	165
1010 0110	A6	166
1010 0111	A7	167
1010 1000	A8	168
1010 1001	A9	169
1010 1010	AA	170
1010 1011	AB	171
1010 1100	AC	172
1010 1101	AD	173
1010 1110	AE	174
1010 1111	AF	175
1011 0000	B0	176
1011 0001	B1	177
1011 0010	B2	178
1011 0011	B3	179
1011 0100	B4	180
1011 0101	B5	181
1011 0110	B6	182
1011 0111	B7	183
1011 1000	B8	184
1011 1001	B9	185
1011 1010	BA	186
1011 1011	BB	187
1011 1100	BC	188
1011 1101	BD	189
1011 1110	BE	190
1011 1111	BF	191

BINARY	HEX	DEC
1100 0000	C0	192
1100 0001	C1	193
1100 0010	C2	194
1100 0011	C3	195
1100 0100	C4	196
1100 0101	C5	197
1100 0110	C6	198
1100 0111	C7	199
1100 1000	C8	200
1100 1001	C9	201
1100 1010	CA	202
1100 1011	CB	203
1100 1100	CC	204
1100 1101	CD	205
1100 1110	CE	206
1100 1111	CF	207
1101 0000	D0	208
1101 0001	D1	209
1101 0010	D2	210
1101 0011	D3	211
1101 0100	D4	212
1101 0101	D5	213
1101 0110	D6	214
1101 0111	D7	215
1101 1000	D8	216
1101 1001	D9	217
1101 1010	DA	218
1101 1011	DB	219
1101 1100	DC	220
1101 1101	DD	221
1101 1110	DE	222
1101 1111	DF	223

BINARY	HEX	DEC
1110 0000	E0	224
1110 0001	E1	225
1110 0010	E2	226
1110 0011	E3	227
1110 0100	E4	228
1110 0101	E5	229
1110 0110	E6	230
1110 0111	E7	231
1110 1000	E8	232
1110 1001	E9	233
1110 1010	EA	234
1110 1011	EB	235
1110 1100	EC	236
1110 1101	ED	237
1110 1110	EE	238
1110 1111	EF	239
1111 0000	F0	240
1111 0001	F1	241
1111 0010	F2	242
1111 0011	F3	243
1111 0100	F4	244
1111 0101	F5	245
1111 0110	F6	246
1111 0111	F7	247
1111 1000	F8	248
1111 1001	F9	249
1111 1010	FA	250
1111 1011	FB	251
1111 1100	FC	252
1111 1101	FD	253
1111 1110	FE	254
1111 1111	FF	255

Refer to actuator nameplate for unit specific approval details

European – Hazardous area

ATEX (94/9/EC) II 2 GD c

Ex d IIB T4 Gb, Ex tb IIIC T120°C Db IP68

Temperature -20 to +70°C (-4 to +158°F)

*Option -30 to +70°C (-22 to +158°F), *Option -40 to +70°C (-40 to +158°F),

*Option -50 to +40°C (-58 to +104°F)

Ex d IIC T4 Gb, Ex tb IIIC T120°C Db IP68

Temperature -20 to +70°C (-4 to +158°F)

*Option -30 to +70°C (-22 to +158°F), *Option -40 to +70°C (-40 to +158°F),

*Option -50 to +40°C (-58 to +104°F)

Ex de IIB T4 Gb, Ex tb IIIC T120°C Db IP68

Temperature -20 to +70°C (-4 to +158°F)

*Option -30 to +70°C (-22 to +158°F), *Option -40 to +70°C (-40 to +158°F),

*Option -50 to +40°C (-58 to +104°F)

Ex de IIC T4 Gb, Ex tb IIIC T120°C Db IP68

Temperature -20 to +70°C (-4 to +158°F)

*Option -30 to +70°C (-22 to +158°F), *Option -40 to +70°C (-40 to +158°F),

*Option -50 to +40°C (-58 to +104°F)

International – Hazardous area

IEC. Exd IIB T4

IEC60079-0 and IEC60079-1 for Exd IIB T4

Temperature -20 to +70°C (-4 to +158°F)

*Option -30 to +70°C (-22 to +158°F), *Option -40 to +70°C (-40 to +158°F),

*Option -50 to +40°C (-58 to +104°F)

IEC. Exd IIC T4

IEC60079-0 and IEC60079-1 for Exd IIC T4

Temperature -20 to +70°C (-4 to +158°F)

*Option -30 to +70°C (-22 to +158°F), *Option -40 to +70°C (-40 to +158°F),

*Option -50 to +40°C (-58 to +104°F)

USA – hazardous Area

FM. Class 1, Division 1, Groups C, D, E, F, G hazardous areas.

Factory Mutual - Explosionproof to NEC Article 500.

Temperature -30°C to +60°C (-22°F to +140°F).

*Option -40°C to +60°C (-40°F to +40°F).

*Alternative for Group B hazardous area. Temperatures as for Groups C and D.

Canada – hazardous Area

CSA EP. Class 1, Division 1, Groups C and D hazardous areas.

Canadian Standard Association - Explosionproof

Temperature -30°C to +70°C (-22°F to +158°F).

*Option -50°C to +40°C (-58°F to +104°F).

*Alternative for Group B hazardous area. Temperatures as for Groups C and D.

International Non hazardous

WT: Standard watertight, BS EN 60529 :1992, IP68, 7 metres/72 hours.

Temperature -30°C to +70°C (-22°F to +158°F).

*Option -40°C to +70°C (-40°F to +158°F).

*Option -50°C to +40°C (-58°F to +104°F).

US – Non hazardous

NEMA 4, 4X and 6.

Temperature -30°C to +70°C (-22°F to +158°F).

*Option -40°C to +70°C (-40°F to +158°F).

*Option -50°C to +40°C (-58°F to +104°F).

Canada – Non hazardous

CSA WT: Canadian Standard Association –Watertight.

Wiring and components complying with CSA Enclosure 4 and 4X.

Temperature -30°C to +70°C (-22°F to +158°F).

*Option -40°C to +70°C (-40°F to +158°F).

*Option -50°C to +40°C (-58°F to +104°F).

Rotork can supply actuators to national standards not listed above.

For details please contact Rotork.

Refer to actuator nameplate for supply voltage and wiring diagram for applicable transformer type.

In order to maintain hazardous area certification only the fuses listed below may be used:

All Transformer types

Fuse FS3 - ATO 20A Fast acting

Transformer Type 1

Fuse FS1 - Bussman TDC11, 250mA, Antisurge 1.5"

Fuse FS2 - Siba 70-065-65, 500V, 5A, Antisurge, 1.5"

Transformer Type 2

Fuse FS1 - Bussman TDC11, 150mA, Antisurge 1.5"

Fuse FS2 - Siba 70-065-65, 500V, 2.5A, Antisurge, 1.5"

Transformer Type 3

Fuse FS1 - Bussman TDC11, 100mA, Antisurge 1.5"

Fuse FS2 - Siba 70-065-65, 500V, 1.5A, Antisurge, 1.5"

Transformer Type 4

Fuse FS1 - Bussman TDC11, 50mA, Antisurge 1.5"

Fuse FS2 - Siba 70-065-63, 500V, 1.6A, Antisurge, 1.5"

ATEX actuators only

FS4 Bussman TDS (100mA - quick blow) or

Littel Fuse 217 (100mA quick blow)

Conditions of Safe Use

- The following are the maximum constructional flame path gaps for ATEX and IECEx Approved actuators.

IQT MAXIMUM FLAMEPATH GAPS

Flamepath	Max. Gap (mm)	Min Length (mm)	Actuator Type and Size
Terminal Cover/Gearcase	0.15	26.7	All Types and Sizes
Terminal Bung Gearcase (IIB)	0.20	25.9	All Types and Sizes
Terminal Bung Gearcase (IIC)	0.115	25.9	All Types and Sizes
Electrical Cover/Gearcase	0.15	26.2	All Types and Sizes
Motor Cover/Gearcase	0.15	25.6	All Types and Sizes
Motor Shaft/Motor Shaft Shroud	0.24	25.2	All Types and Sizes
Motor Shaft Shroud/Gearcase	-0.05/0.00	25.0	All Types and Sizes
Encoder Shaft/encoder Shaft Shroud	0.24	25.2	All Types and Sizes
Encoder Shaft Shroud/Gearcase	-0.05/0.00	25.0	All Types and Sizes

Note Negative Sign denotes an interference fit.

- The actuator must only be located where the risk of impact upon the window is low.

Appendix A

EL Partial Stroke – Limit

The end of travel limit from which the partial stroke test will start and end must be set.

The default limit for partial stroke is Open limit, under test the actuator will automatically move closed from the open limit to the set position and then return to the open limit position.

To set the closed limit for partial stroke **[EL]**, Press the **+** or **-** key to change from Open **[EL OP]** to Closed **[EL CL]**.

PRESS THE  KEY.



The display option will flash **[Stored]** indicating it has been set.

EP Partial Stroke – Position

A position can be set between 1% and 97% to give a set point within the travel to which the partial stroke runs.

To set the partial stroke position, Press the **+** or **-** key to scroll between 1% and 97%. A minimum 3% Stroke is required from open limit to allow the actuator to perform the partial stroke adequately.

PRESS THE  KEY.

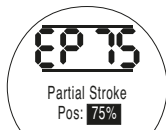

The display option will flash **[Stored]** indicating it has been set.

Et Partial Stroke – Timeout

The timeout function allows a reasonable amount of time to be set for the partial stroke to complete one cycle. An alarm can be set to activate if the stroke hasn't been completed in the set time. Refer to Section 9.2 (indication contacts). The Partial Stroke timeout must be set to a value greater than that required to complete the Partial Stroke under normal operating conditions.

To set the partial stroke timeout, press the **+** or **-** key to scroll up or down in 10 second intervals.

Set the required time and **PRESS THE  KEY.**



The display option will flash **[Stored]** indicating it has been set.



Rotork Sales and Service

If your Rotork actuator has been correctly installed and sealed, it will give years of trouble-free service.

Should you require technical assistance or spares, Rotork guarantees the best service in the world. Contact your local Rotork representative or the factory direct at the address on the nameplate, quoting the actuator type and serial number.

A full listing of our worldwide sales and service network is available on our website at www.rotork.com

rotork[®]

Head Office

Rotork PLC
Brassmill Lane
Bath
BA1 3JQ

tel +44 (0)1225 733200
email mail@rotork.com

Local representative:





Notes



ATTENTION: RED PLASTIC PLUGS IN CONDUIT ENTRIES ARE FOR TRANSIT ONLY.
FOR LONG TERM PROTECTION FIT SUITABLE METAL PLUGS.

ATTENZIONE: I TAPPI IN PLASTICA ROSSA PER L'ENTRATA CAVI SONO SOLO
TEMPORANEI. PER UNA PROTEZIONE PERMANENTE PREGO SOSTITUIRLI CON
APPOSITI TAPPI METALLICI.

ATENCIÓN: LOS TAPONES ROJOS DE PLÁSTICO EN LAS ENTRADAS DE CABLE
SON ÚNICAMENTE PARA TRANSPORTE. PARA PROTECCIÓN PERMANENTE
COLOCAR TAPONES METÁLICOS APROPIADOS.

ACHTUNG: DIE ROTEN PLASTIKSTOPFEN SIND NUR FÜR DEN TRANSPORT
GEEIGNET. FÜR DAUERHAFTEN SCHUTZ SIND DIESE GEGEN GEEIGNETE
BLINDSTOPFEN AUSZUTAUŠCHEN.

ATTENTION: LES BOUCHONS PLASTIQUES ASSURENT UNE PROTECTION
TEMPORAIRE. POUR UNE PROTECTION DEFINITIVE UTILISER DES BOUCHONS
METALLIQUES.

注意：コンジット口の赤色プラグは、輸送用を目的としたプラグです。
長期に渡る保護の場合、適切なメタルプラグをご使用ください。

注意：接线端红色塑料封口仅为运输途中使用。
长期正常保护时请用金属封口。

주의: 배선인입구의 빨간색 플라스틱 플러그는 오직 임시용입니다.
오래 보관하기 위해서는 규격에 맞는 금속 플러그를 사용하십시오.

Formerly E175-3E. As we are continually developing our products, the design of Rotork actuators is subject to change without notice. The latest product and technical information is available at our website: www.rotork.com.

The name Rotork is a registered trade mark. Rotork recognises all registered trade marks.

POWTG1020