

Staflux 187

High Medium Pressure Gas Regulator



TECHNICAL BROCHURE

Pietro Fiorentini S.p.A.

Via E.Fermi, 8/10 | 36057 Arcugnano, Italy | +39 0444 968 511
sales@fiorentini.com

The data are not binding. We reserve the right
to make changes without prior notice.

staflux187_technicalbrochure_ENG_revB

www.fiorentini.com

Who we are

We are a global organization specialized in designing and manufacturing technologically advanced solutions for natural gas treatment, transmission and distribution systems.

We are the ideal partner for operators in the Oil & Gas sector, with a business offer that goes across the whole natural gas chain.

We are in constant evolution to meet our customers' highest expectations in terms of quality and reliability.

Our aim is to be a step ahead of the competition, with customized technologies and an after-sale service program undertaken with the highest grade of professionalism.



Pietro Fiorentini advantages



Localised technical support



Experience since 1940



We operate in over 100 countries

Area of Application

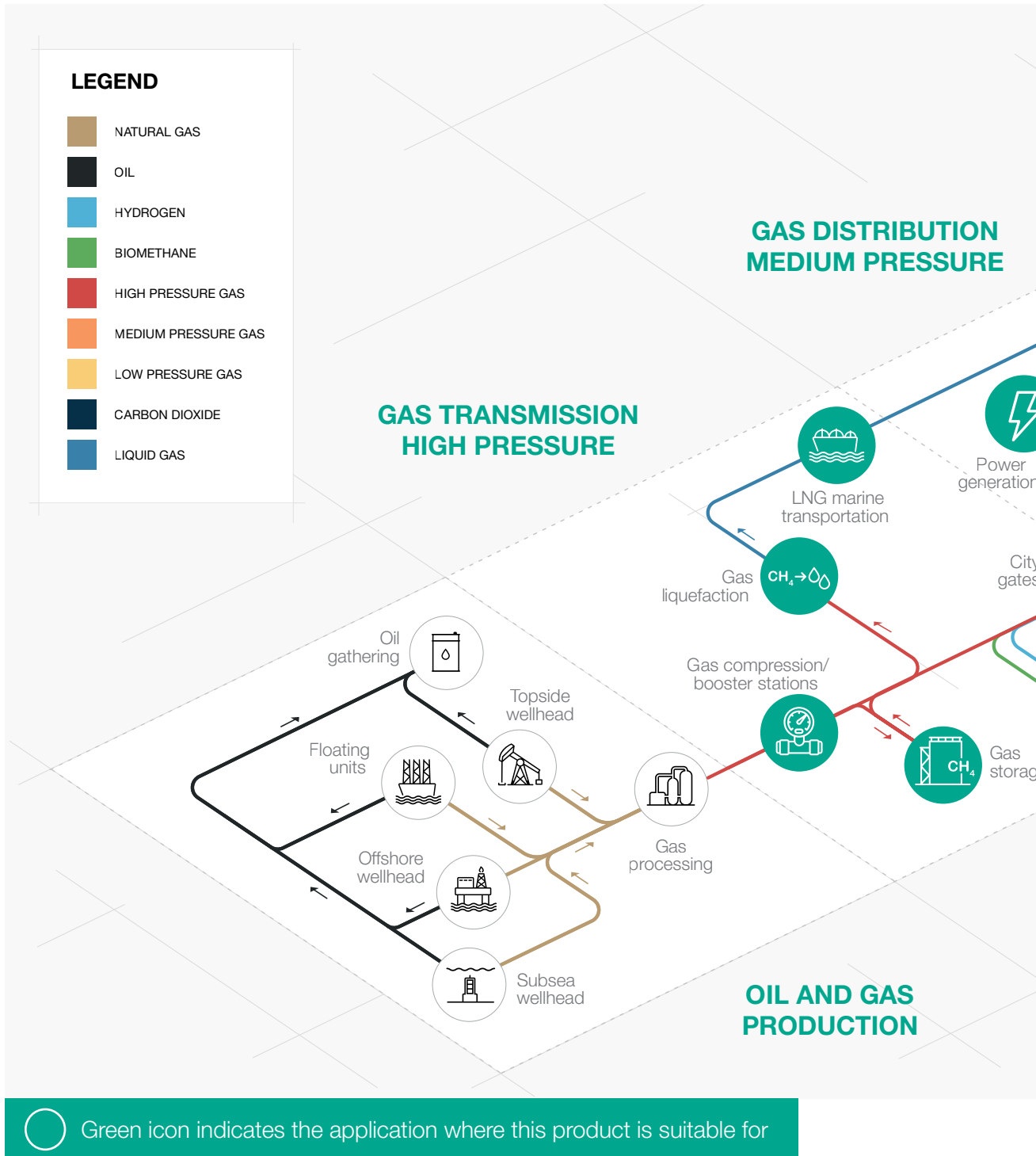

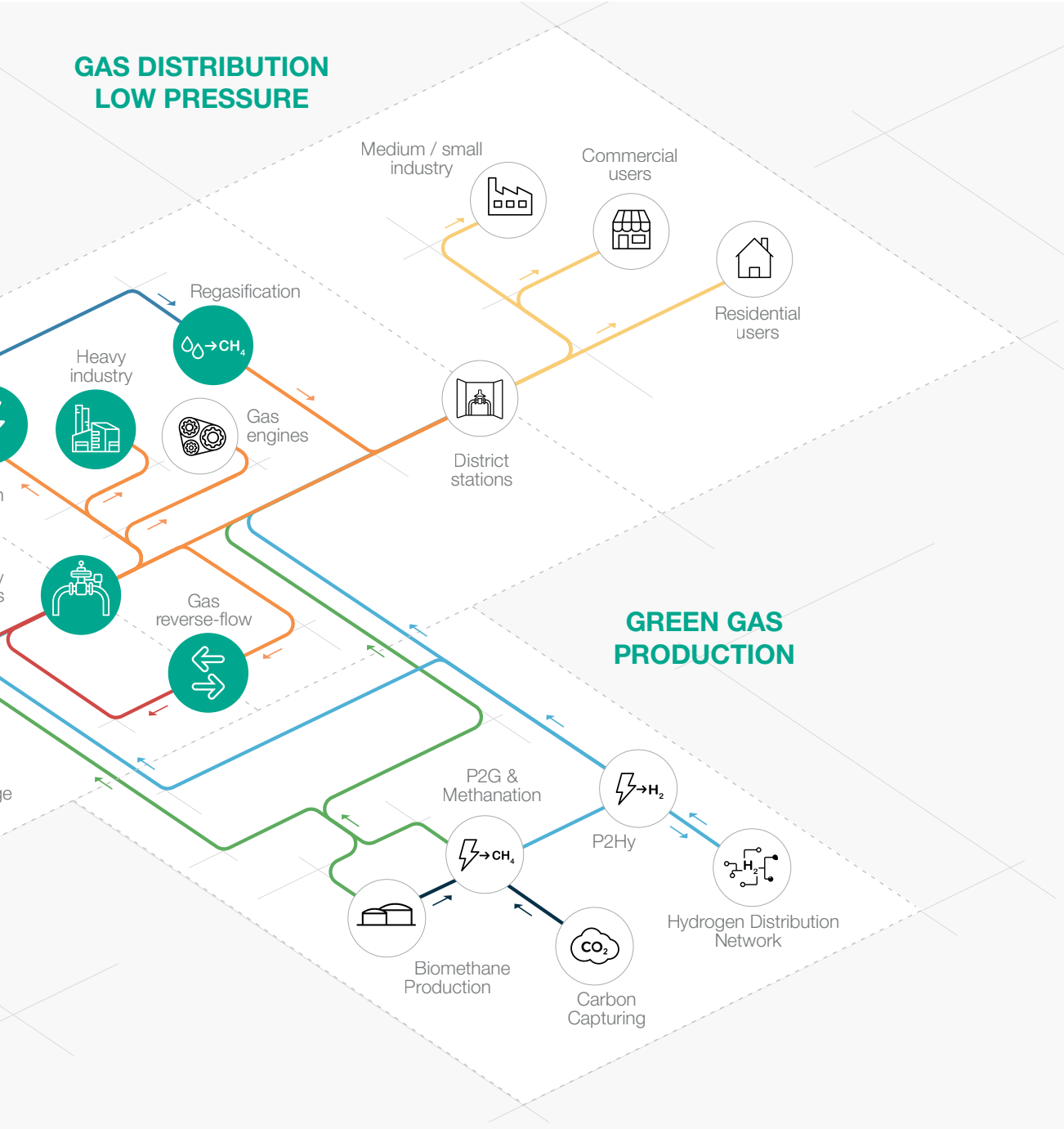

Figure 1 Area of Application Map



Introduction

Staflux 187 is one of the **direct-operated gas pressure regulators** designed and manufactured by Pietro Fiorentini.

This device is suitable for use with previously filtered non-corrosive gases, and it is mainly used for high-pressure transmission systems and for medium pressure natural gas distribution networks.

According to the European Standard EN 334, it is classified as **Fail Open**.

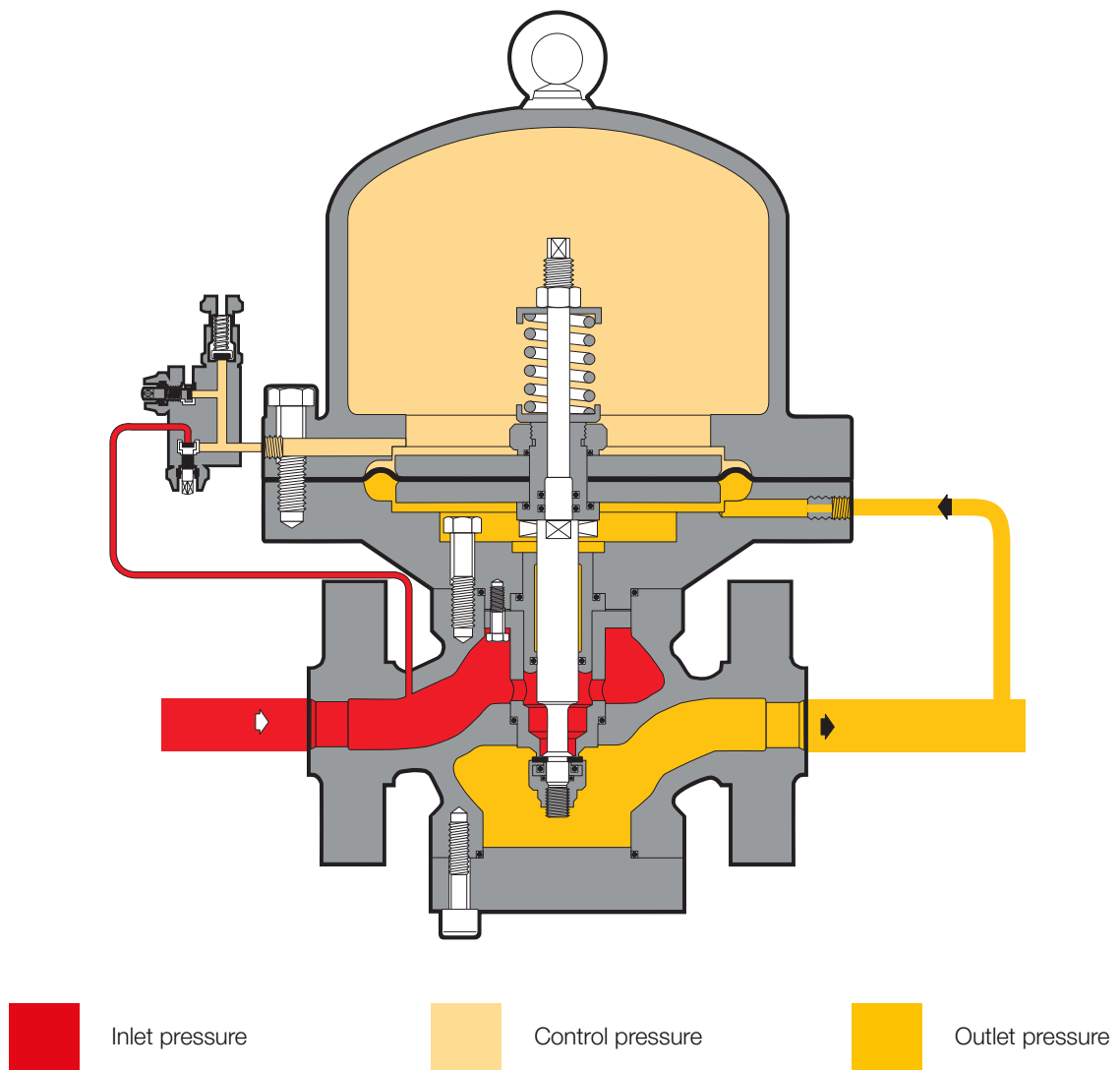

Figure 2 Staflux 187

Features and Calibration ranges

Staflux 187 is a direct action device for high pressure, controlled by a diaphragm and contrasting regulated counter pressure action.

Staflux 187 is a balanced pressure regulator. This means that the controlled outlet pressure is not affected by variations in the inlet pressure and flow during its operation. Therefore a balanced regulator can have a single-size orifice for all pressure and flow conditions.

This regulator is also suitable for use with previously filtered, non corrosive gases. It is a **truly top entry design** which allows an **easy maintenance** of parts directly in the field **without removing the body from the pipework**.

Set point adjustment of the regulator is achieved via a three way / two valve unit, loading and unloading the pressure in the top chamber.

A small capacity relief valve prevents set pressures at values beyond limits and, at the same time, protects the pressurised chamber from overpressure subsequent to high ambient temperatures.

Pressure in the top chamber creates the counter action similar to the one of a spring in more conventional regulators.

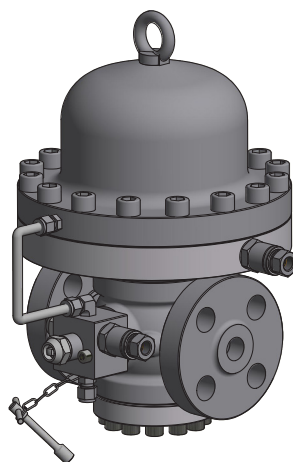

Figure 3 Staflux 187



Staflux 187 competitive advantages



Compact and simple design



Easy maintenance



Operates with high differential pressure



Balanced type



Does not require gas pre-heating



Biomethane compatible and available with specific versions for full Hydrogen or blending



Top Entry

Features

Features	Values
Design pressure*	up to 25.0 MPa up to 250 barg
Ambient temperature*	from -20 °C to +60 °C from -4 °F to +140 °F
Inlet gas temperature range*	from -20 °C to +60 °C from -4 °F to +140 °F
Inlet pressure range bpu (MAOP)	from 0.2 to 25 MPa from 2 to 250 barg
Range of downstream pressure Wd	from 0.1 to 7.5 MPa from 1 to 75 barg
Minimum differential pressure	0.1 MPa 1 barg
Accuracy class AC	up to 5 (depending on working conditions)
Lock-up pressure class SG	up to 10 (depending on working conditions)
Nominal dimensions DN	DN 25 / 1";
Connections*	Class 1500 RF or RTJ according to ASME B16.5

(*) REMARK: Different functional features and/or extended temperature ranges available on request. Stated temperature ranges are the maximum for which the equipment's full performance, including accuracy, are fulfilled. Standard product may have a narrower range.

Table 1 Features

Materials and Approvals

Part	Material
Body	Cast steel ASTM A352 LCC
Cover	ASTM A350 LF2 carbon steel
Stem	AISI 416 stainless steel
Seat	Stainless steel
Diaphragm	Vulcanized rubber
Sealing ring	Nitrile rubber
Compression fittings	Zinc-plated carbon steel

REMARK: The materials indicated above refer to the standard models. Different materials can be provided according to specific needs.

Table 2 Materials

Construction Standards and Approvals

Staflux 187 regulator is designed according to European standard EN 334. The regulator reacts in opening (Fail Open) according to EN 334.

The product is certified according to European Directive 2014/68/EU (PED). Leakage class: bubble tight, better than VIII according to ANSI/FCI 70-3.



EN 334



PED-CE



Springs ranges and control heads

Type	Model	Operation	Range Wh		Spring Table web link
			MPa	barg	
Relief Valve	VS/FI	Manual	0.4 - 7.5	4 - 75	TT 673

Table 3 Settings table

General link to the calibration tables: [PRESS HERE](#) or use the QR code:



Accessories

In-line Monitor

The in-line monitor is generally installed upstream of the active regulator.

Although the function of the monitor regulator is different, the two regulators are virtually identical from the point of view of their mechanical components.

The only difference is that monitor is set at a higher pressure than active regulator.

The Cg coefficient of the active regulator is the same, however during the sizing process, the differential pressure drop generated by the fully open in-line monitor shall be considered.

As a general practise to incorporate this effect, a 20% reduction of the Active regulator's Cg value can be applied.

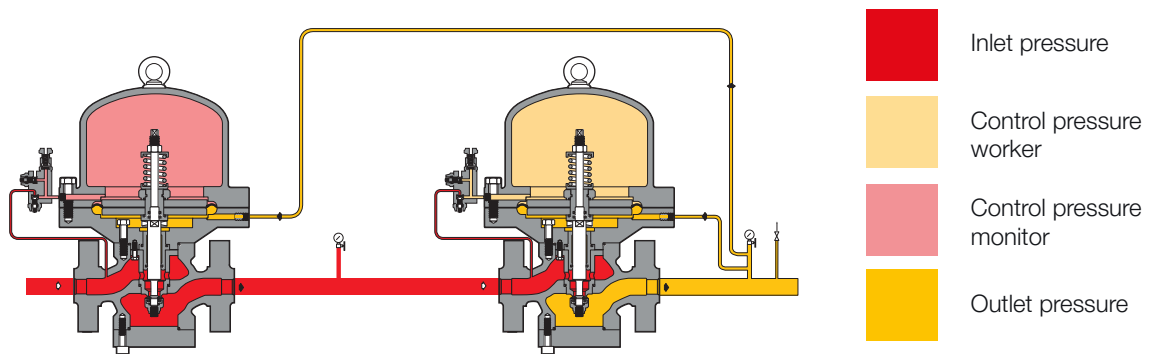









Figure 4 Staflux 187 with In-line monitor setup

SBC/187 in-line slam shut

A SBC 187 slam shut can be installed upstream of the Staflux 187 pressure regulator acting as an overpressure protection device.

The main characteristics of this slam shut device are:

-  Over Pressure Shut-Off
-  Under Pressure Shut-Off
-  Internal by-pass
-  Push button for tripping test
-  Compact dimensions
-  Easy maintenance
-  Remote tripping option
-  Limit switch option

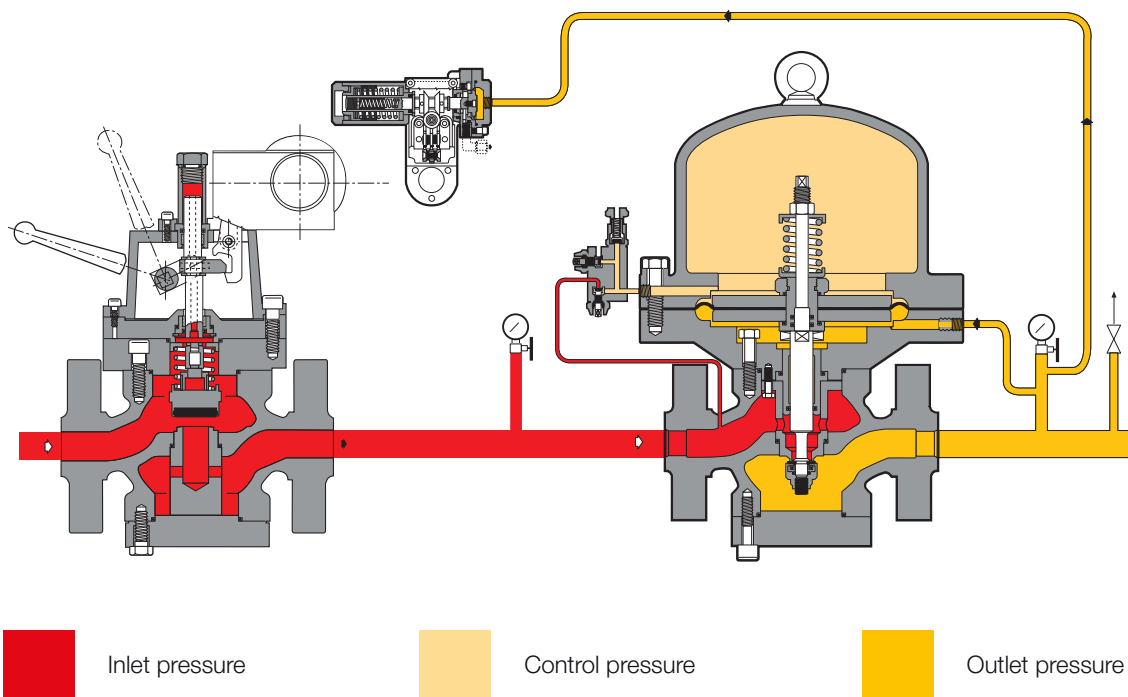

Figure 5 Staflux 187 with in-line slam shut SBC/187



Weights and Dimensions

Staflux 187

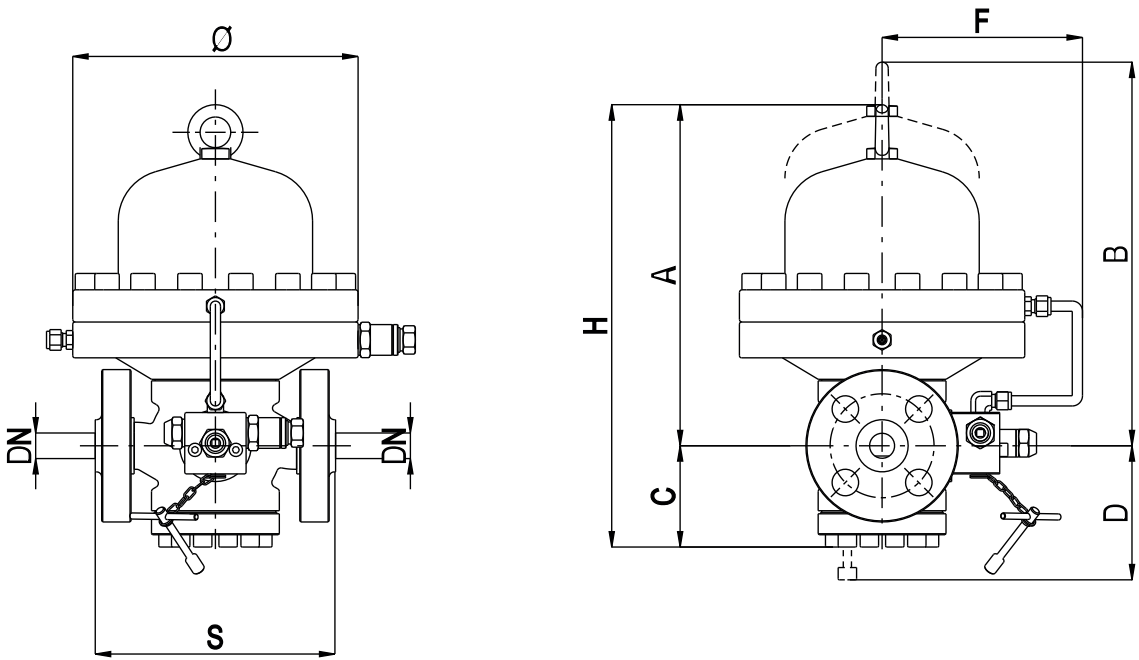

Figure 6 Staflux 187 dimensions

Weights and Dimensions (for other connections please contact your closest Pietro Fiorentini representative)	
	[mm] inches
Size (DN)	25 1"
S - ANSI 1500	235 9.25"
Ø	280 11.02"
A	335 13.19"
B	435 17.13"
C	100 3.94"
D	130 5.12"
F	195 7.68"
H	435 17.13"
Tubing connections	Øe 10 x Øi 8 (on request imperial sizing)
Weight	
ANSI 1500	53 2

Table 4 Weights and dimensions

Sizing and Cg

In general, the choice of a regulator is made based on the calculation of the flow rate determined by the use of formulae using the flow rate coefficients (Cg) and the form factor (K1) as indicated by the EN 334 standard.

Flow rate coefficient	
Nominal size	25
Inches	1"
Cg	130
K1	106.78

Table 5 Flow rate coefficient

For sizing [PRESS HERE](#) or use the QR code:



Note: In case you do not have the proper credentials to access, feel free to contact your closest Pietro Fiorentini representative.

In general the online sizing considers multiple variables as the regulator is installed in a system, enabling a better and multiperspective approach to the sizing.

For different gases, and for natural gas with a different relative density other than 0.61 (compared to air), the correction coefficients from the following formula shall be applied:

$$F_c = \sqrt{\frac{175,8}{S \times (273,16 + T)}}$$

S = relative density (refer to table 6)
T = gas temperature (°C)



Correction Factor Fc		
Gas Type	Relative Density S	Correction Factor Fc
Air	1.00	0.78
Propane	1.53	0.63
Butane	2.00	0.55
Nitrogen	0.97	0.79
Oxygen	1.14	0.73
Carbon Dioxide	1.52	0.63

Note: the table shows the Fc correction factors valid for Gas, calculated at a temperature of 15°C and at the declared relative density.

Table 6 Correction factor Fc

Flow rate conversion
Stm ³ /h x 0.94795 = Nm ³ /h

Nm³/h reference conditions T= 0 °C; P= 1 barg
 Stm³/h reference conditions T= 15 °C; P= 1 barg

Table 7 Flow rate conversion

CAUTION:

In order to get optimal performance, to avoid premature erosion phenomena and to limit noise emissions, it is recommended to check that the gas speed at the outlet flange does not exceed the values of the graph below. The gas speed at the outlet flange may be calculated by means of the following formula:

$$V = 345.92 \times \frac{Q}{DN^2} \times \frac{1 - 0.002 \times Pd}{1 + Pd}$$

V = gas speed in m/s
 Q = gas flow rate in Stm³/h
 DN = nominal size of regular in mm
 Pd = outlet pressure in barg

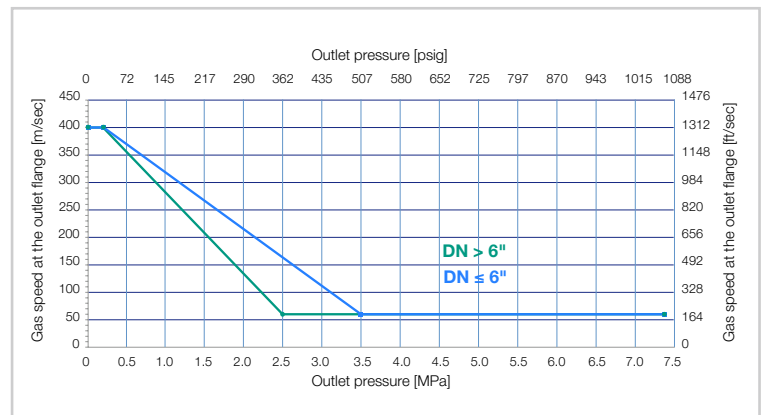



Pietro Fiorentini

TB0009ENG



The data are not binding. We reserve the right
to make changes without prior notice.

staflux187_technicalbrochure_ENG_revB

www.fiorentini.com