

scan for mobile



# GENIE<sup>®</sup> GHR

Heated Regulator

## PRODUCT MANUAL: GHR-CSA

### Overview

### Installation & Operation

901-GR Instructions

GHR Instructions

INTERTEC<sup>™</sup> 24

INTERTEC<sup>™</sup> 110

### Maintenance Instructions



Controller Option

Heater Block Option



## The Sampling Experts<sup>™</sup>



Leading the industry in Analytically Correct<sup>™</sup> Sampling Systems, Components, and Technology. By applying sound principles of science and a minimalistic design approach, we manufacture our products to solve your specific sampling needs. We specialize in Analytically Correct Sample System Design, Sample Conditioning Components, and revolutionary gas and liquid sampling technology. **We are The Sampling Experts<sup>™</sup>.** ISO 9001:2015 certified

Genie<sup>®</sup>, GHR<sup>™</sup>, are trademarks or registered trademarks of A+ Corporation, LLC. All other referenced trademarks are the property of their respective owners. © 2012 A+ Corporation. All rights reserved.  
SCC-GHR-COVER\_032224



Contact us for expert product application assistance.  
**1.225.644.5255** | [geniefilters.com](http://geniefilters.com)  
[sales@geniefilters.com](mailto:sales@geniefilters.com)

**A+ Corporation**  
41041 Black Bayou Road  
Gonzales, Louisiana 70737 United States

## Introduction

- This manual is intended to be used as a basic installation, operation, and maintenance guide for this product and should be left with the end user for future reference. It has been carefully checked for accuracy.
- Proper installation is the responsibility of the installer. Product failure due to improper installation is not covered under the warranty. If you receive a damaged product, please contact your distributor immediately.
- Installation of this product is of a mechanical nature. The installer and operator should understand how to use tube fittings and be trained in installing this type of equipment.

## Technical Specifications

The specifications listed in this section are generalized for this product. Please note that specifications may vary depending on the customizations of your equipment.

Technical Specifications	
<b>Maximum pressure rating</b>	6000 psig (413.7 barg) per criteria of ANSI/ASME B31.3
<b>Outlet pressure range</b>	0-10 psig (0-0.7 barg), 0-25 psig (0-1.7 barg), 0-50 psig (0-3.4 barg), 0-100 psig (0-6.9 barg), 0-250 psig (0-17.2 barg), 0-500 psig (34.5 barg)
<b>Temperature range</b> <small>* Actual limit depends on sealing material chosen. Refer to Temperature Range Comparison Chart.</small>	<b>*Ambient:</b> GHR (CSA): -40 to 300°F (-40 to 149°C) 901-GR: 0 to 145°F (-18 to 63°C) GHR (ATEX): -40 to 140°F (-40 to 60°C) <b>*Process (all models):</b> -40°F to 300°F (-40°F to 149°C) <b>901-GR controller:</b> 95 to 300°F (35 to 149°C) set at 300°F (149°C); backup thermal cutoff opens at 338°F (170°C)
<b>Port sizes</b>	1/4" FNPT
<b>Cv Coefficient</b>	0.023
<b>Maximum flow rate</b>	~10 SLM - Standard Liters per Minute (consider heat transfer limitations)
<b>Wetted materials</b>	<b>Machined parts:</b> 316/316L stainless steel / ISO 15156-3 compliant <b>All other metal parts:</b> stainless steel / ISO 15156-3 compliant <b>Regulator seat material:</b> PFA <b>Seals:</b> User defined
<b>Electrical connection</b>	<b>Conduit (CSA):</b> GHR: 1/2" FNPT 901-GR: 3/4" FNPT <b>Cable OD (ATEX/IECEx):</b> 3/8" (10mm)
<b>Power requirements</b>	GHR: 80W @110/220 VAC or 25W @ 24 VDC 901-GR: 200 W @ 110 VAC or 700 W @ 240 VAC
<b>Electrical approval</b>	CSA: Class 1, Division 1, Groups B, C, & D; T3 ATEX/IECEx (Model GHR only): II2G Ex db IIC T3



Leading the industry in Analytically Correct™ Sampling Systems, Components, and Technology. By applying sound principles of science and a minimalistic design approach, we manufacture our products to solve your specific sampling needs. We specialize in Analytically Correct Sample System Design, Sample Conditioning Components, and revolutionary gas and liquid sampling technology. We are The Sampling Experts™. ISO 9001:2015 certified

Genie®, GHR™, are trademarks or registered trademarks of A+Corporation, LLC. All other referenced trademarks are the property of their respective owners. © 2012 A+ Corporation. All rights reserved. SCC-GHR-OVERVIEW\_032224



Contact us for expert product application assistance.

**1.225.644.5255**  
sales@geniefilters.com

geniefilters.com

41041 Black Bayou Road  
Gonzales, Louisiana 70737 United States



## Model Numbering & Additional Part Numbers

Your model number is determined by your specific needs. Materials of construction must be compatible with process fluid.

<b>Model</b>	GHR = GR with self-limiting block heater		901-GR = GR with temperature controller			
<b>Sealing material</b>	0 = Fluoroelastomer		JW = RGD resistant HNBR		(other materials available upon request)	
<b>Outlet pressure range (psig)</b>	0 = 0-25	1 = 0-50	2 = 0-100	3 = 0-250	4 = 0-500	9 = 0-10
<b>Power requirements</b>	1 = AC power		2 = DC power (not available in Model 901-GR)			
<b>Electrical approval</b>	C = CSA		A = ATEX/IECEX (not available in Model 901-GR)			

### How to build the model number:

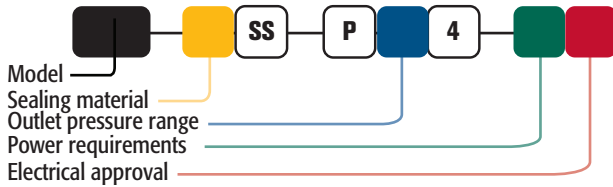

### How to build the heater block replacement model number:



### Spare Parts & Accessories (sold separately)

- Kozy™ Insulated Cover - Part # KZ-10-L (not for enclosures)
- 901 Heater Base & Controller Replacement - Part # 901-00-SS
- Manifold with pressure gauge, ball valve, & relief valve - for ordering information, refer to the Genie® Probe Regulator Accessory Manifold product sheet
- Inlet filter replacement - Part # GHR-5FSS
- Seat & Seal replacement kit - Seat, Valve Stem, Bias Spring & O-Rings

## Product Dimensions

### GHR

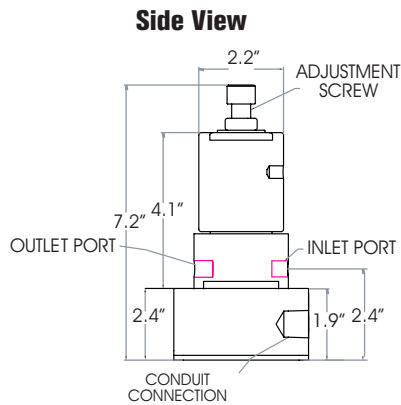

### Top View

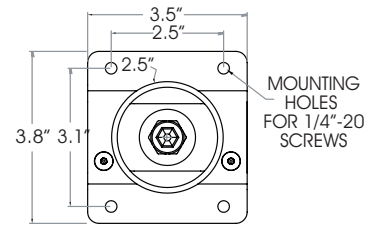

### 901-GR

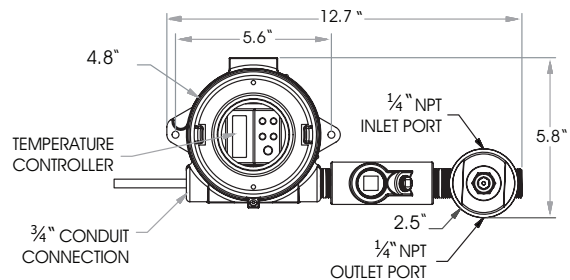
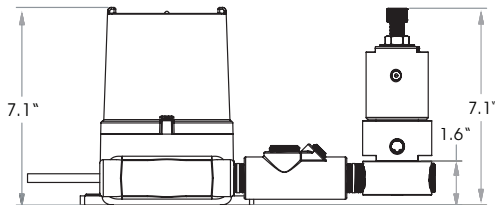





# BEFORE YOU START





## Safety Warnings

The images below will be used to alert you to various types of safety messages. Obey all safety messages that follow this symbol to avoid possible injury/death or equipment damage.

 **WARNING** messages will appear before procedures that could result in *serious personal injury or death*.

 **CAUTION** messages will appear before procedures that could result in *minor or moderate injury*.

 **NOTICE** messages will appear before procedures that could result in *damage to equipment*.

 **WARNING:** Read this manual completely and carefully before installing or using this product. Failure to do so can result in serious injury or death. Save these instructions for future reference and for the local inspector's use. Observe all governing codes and ordinances.

## General

- Improper selection/installation/maintenance, misuse, or abuse of this equipment can cause death, serious injury, and property damage.
- Do not exceed ANY equipment pressure ratings. Refer to the technical specifications table for maximum pressure rating of the system. Verify the designed pressure ratings of all equipment in your system (supply lines, fittings, connections, filters, valves, gauges, etc.). Prior to use in a system, a properly-sized relief device is to be installed, which limits the use of 110% of the MAWP.
- Some fluids, when burning, do not exhibit a visible flame. Use extreme caution when inspecting and/or servicing systems using flammable fluids to avoid death or serious injury to personnel. Provide a device to warn personnel of these dangerous conditions.
- Not designed for external fire or for use with mixtures of an explosive gas and air/oxygen.
- Do not use the regulator as a shut-off device. A ball valve on the outlet is recommended for this purpose. Our Genie Regulator Accessory Manifold™ is designed to thread directly into any Genie Probe Regulator™ or Genie Regulator and provides a means to monitor regulator outlet pressure and block flow.

## 901-GR Electrical

 **WARNING:** Electrical power must be "OFF" before and during installation and maintenance or personal injury may result.

- 901-GR**
- All appropriate national, state, and electrical codes must be followed.
  - Do not remove the temperature controller from the instrument enclosure; the wires may disconnect from the controller terminals.
  - To adjust the set temperature of the heated regulator, remove the instrument enclosure cover and use the arrow keys to adjust the set temperature. This must be done in a non-hazardous location prior to installation. Note: the range of adjustment is 95°F to 300°F.
  - When installed in a hazardous location, the instrument enclosure cover should NOT be removed unless power to the regulator is de-energized prior to maintenance.
  - Do not exceed 5 minutes with power without fluid flow or the thermal cut-off will open the circuit.
  - A sealing fitting must be installed with access, allowing the dams to be made and the sealing compound to be properly poured.
  - All unused conduit openings must be plugged. Plugs must be a minimum of 1/8" thick and engage in a minimum of 5 full threads.

## GHR Electrical

 **WARNING:** Electrical power must be "OFF" before and during installation and maintenance or personal injury may result.

- GHR**
- All appropriate national, state, and electrical codes must be followed. In Europe, EN 60079-14 latest applicable edition should be followed.
  - The power supply is with the help of a silicone cable, notch and oil resistant. The cable is intended for installation inside a rigid metal conduit, cable tray or a similar method which provides sufficient mechanical strength to the cable against stress and bending. Ground to be provided at the final location of installation.



Leading the industry in Analytically Correct™ Sampling Systems, Components, and Technology. By applying sound principles of science and a minimalistic design approach, we manufacture our products to solve your specific sampling needs. We specialize in Analytically Correct Sample System Design, Sample Conditioning Components, and revolutionary gas and liquid sampling technology. **We are The Sampling Experts™.** ISO 9001:2015 certified

Genie®, GHR™, are trademarks or registered trademarks of A+Corporation, LLC. All other referenced trademarks are the property of their respective owners. © 2012 A+ Corporation. All rights reserved. SCC-GHR-Installation\_031423



Contact us for expert product application assistance.

**1.225.644.5255**  
[sales@geniefilters.com](mailto:sales@geniefilters.com)

[geniefilters.com](http://geniefilters.com)

41041 Black Bayou Road  
 Gonzales, Louisiana 70737 United States





## 901-GR Installation and Operation Notes

**⚠ NOTICE:** Do not install the regulator in an enclosure that is heated above the regulator's maximum ambient temperature.

- The regulator should be installed in a KOZY™ insulated jacket, ACES™ enclosure, or similar type of insulating device.
- Valve off sample flow prior to regulator installation.

### Required Tools and Materials

- Gloves
- (2) 1/4" screws
- Screwdriver
- 3/8" allen wrench for setting outlet pressure
- Crescent wrench for general purpose

## 901-GR 1. Mount

1. The regulator can be mounted in any position, preferably with the heater at the bottom so heat can rise into the body of the regulator.
2. Using the screw driver, affix the regulator to the enclosure/panel by inserting (2) 1/4" screws into the mounting tabs on the controller enclosure.

## 901-GR 2. Connect tubing

1. Connect tubing from the sample stream to the inlet port.
2. Connect tubing from the outlet port to the next device in the sample system.
3. The 901-GR is a non-venting regulator. The port that is not labeled is an atmospheric reference port for the regulator. If required, tubing can be connected to transport hazardous process gases to a safe area, in the event of a regulator seal failure.

**⚠ NOTICE:** **DO NOT** plug the atmospheric reference port or the regulator's performance will be affected.



## 901-GR 3. Connect power

**⚠ NOTICE:** Verify that the heater voltage matches the voltage of the available power supply. Damage to the unit can occur if the wrong source power is applied.

1. With the electrical power off, connect the power source to the wire pigtail as follows: black wire to line/hot, white wire to neutral, green wire to ground/earth.
2. A sealing fitting is required on the AC power supply within 18 inches of enclosure. Add fiber and sealing compound to the sealing fittings. Sealing fittings are approved for use in hazardous locations only when fiber and sealing compound are used to make the seal.

## 901-GR 4. Power up

1. Turn power on.
2. Allow the regulator to be powered for 2-5 minutes before starting flow through the regulator.

**⚠ NOTICE:** **DO NOT** exceed 5 minutes of power without fluid flow or the thermal cut-off will open the circuit.

901-GR  
**5.**

## Establish flow and adjust pressure

**⚠ CAUTION:** The regulator will be HOT. Perform the following steps with gloves on to avoid burns.

1. Slowly open external valving to avoid a sudden surge in fluid or pressure.
2. Use a 3/8" allen wrench to turn the allen cap pressure adjustment screw located on top of the regulator to adjust pressure while gas is flowing through the regulator. To raise the outlet pressure, turn the screw clockwise. To lower the outlet pressure, turn the screw counterclockwise.
3. Monitor outlet pressure and flow for the next 30 minutes or until both stabilize. The pressure adjustment set point may have to be adjusted once the temperature is stabilized.
4. Once pressure and flow are stable, use a crescent wrench to firmly tighten the locking nut around the pressure adjustment screw to prevent unintended changes in pressure adjustment.

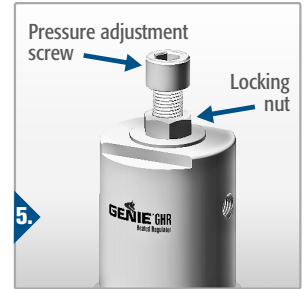



## GHR Installation and Operation Notes

- The regulator should be installed in a KOZY™ insulated jacket, ACES™ enclosure, or similar type of insulating device.
- For ATEX, refer to the “Temperature Limitations” section of the enclosed INTERTEC document for information concerning the heat transfer coefficient of the enclosure surrounding the regulator. Our KOZY™ insulated jacket and INTERTEC enclosures used in our ACES™ systems meet this requirement.
- Bracket mounting is optional, but is suggested as mounting makes it stationary for quick and easy operation.
- Valve off sample flow prior to regulator installation.

## Required Tools and Materials

- Gloves
- (4) 1/4” screws for mounting
- Screwdriver
- 3/8” allen wrench for setting outlet pressure
- Crescent wrench for general purpose

### GHR 1. Mount

1. The regulator can be mounted in any position, preferably with the block heater at the bottom so heat can rise into the body of the regulator.
2. Use of insulating washers between the regulator and the enclosure/panel is recommended to maximize block heater efficiency. Position the (4) insulating washers over the holes that have been drilled for mounting.
3. Place the regulator over the insulating washers with bracket holes aligned over the washers’ holes.
4. Affix the regulator to the enclosure/panel by inserting (4) 1/4” screws into the mounting bracket holes and tighten with a screwdriver.

### GHR 2. Connect tubing

1. Connect tubing from the sample stream to the inlet port.
2. Connect tubing from the outlet port to the next device in the sample system.
3. The GHR™ is a non-venting regulator. The port that is not labeled is an atmospheric reference port for the regulator. If required, tubing can be connected to transport hazardous process gases to a safe area, in the event of a regulator seal failure.

**⚠ NOTICE: DO NOT** plug the atmospheric reference port or the regulator’s performance will be affected.



### GHR 3. Connect power

**⚠ NOTICE:** Verify that the block heater voltage matches the voltage of the available power supply.

1. Refer to the INTERTEC literature provided with the unit for electrical wiring. In Europe, EN 60079-14 latest applicable edition should be followed.

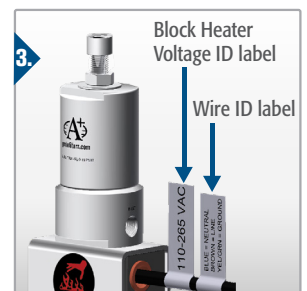

### GHR 4. Power up

1. Turn power on.
2. Allow at least 10 minutes for the block heater to warm before moving on to the next step.

(continued)



## **GHR** 5. Establish flow and adjust pressure

**⚠ CAUTION:** The regulator will be HOT. Perform the following steps with gloves on to avoid burns.

1. Slowly open external valving to avoid a sudden surge in fluid or pressure.
2. Use a 3/8" allen wrench to turn the allen cap pressure adjustment screw located on top of the regulator to adjust pressure while gas is flowing through the regulator. To raise the outlet pressure, turn the screw clockwise. To lower the outlet pressure, turn the screw counterclockwise.
3. Monitor outlet pressure and flow for the next 30 minutes or until both stabilize. The pressure adjustment set point may have to be adjusted once the temperature is stabilized.
4. Once pressure and flow are stable, use a crescent wrench to firmly tighten the locking nut around the pressure adjustment screw to prevent unintended changes in pressure adjustment.

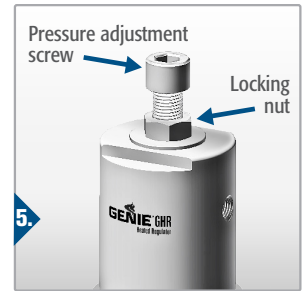



Protected operating conditions



www.intertec.info

# SL BLOCKTHERM C 24 V Self-limiting Block Heater

## 1 Application

The self-limiting electric conduction heater is designed to be attached directly to manifolds, measuring or analyzing instruments, control valves and similar equipment installed in hazardous areas. It heats the device by conduction. This is the easiest, safest and most economical method of freeze protection or temperature maintenance.

## 2 Features & Advantages

- Energy saving, high output
- Self-limiting, no fusible link or limiter
- Compact, requires very little space
- Adjusts automatically to the voltage

## 3 Description

BLOCKTHERM is a metal heating block with a 1/2" NPT thread to connect to a conduit. The PTC cartridge provides the heat that is transferred through the heater block to the device to which it is attached.

## 4 Performance

A conduction heater requires considerably less power than a finned convection heater, as the heat conduction qualities of metal are much better than those of air. The air surrounding the whole installation in the enclosure serves as additional insulation.

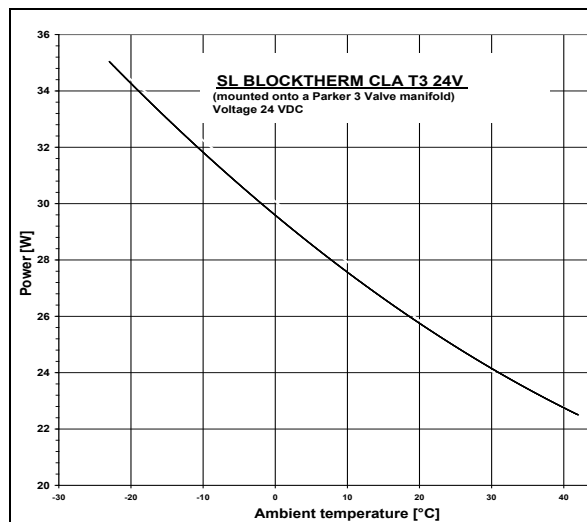

## 5 Technical Data

Type	CLA T3	NLA
Length of Block (see Pt.10)	4.1" / 105 mm	4,1" / 105mm
Type of Protection	CSA Cl.I, Div. 1, Groups A,B,C,D	-
Certificate	File # 1655545 (LR 43674)	-
Temperature Class	T3	-
Nominal Voltage	24 V	
Nominal Power	25 W	
Connection Cable	Silicone cable, notch and oil resistant, 3x1,5 mm <sup>2</sup> , Ø8,5 mm	
Conduit connection	1/2" NPT	
Length of cable	39" / 1 m	
Ambient temp. range	-58 to 356 F -50 to +180°C	
Ingress Protection	IP68	
Material	Seawater-proof aluminum, black anodized	

All INTERTEC explosion-proof heaters can also be provided in European ATEX standard.

## 6 Options

TSxx Kit	Thermostat with junction box
S	Material: Stainless steel body
AM	Failure alarm, opens at < +5°C
3M	Connection cable 10' / 3m long



# SL BLOCKTHERM C 24 V Self-limiting Block Heater

## 7 Temperature Limitation

PTC-Elements (Positive Temperature Coefficient) raise their electric resistance with rising temperature. High resistance results in low heating power. The heating power is very low at high temperatures so that the temperature cannot exceed the maximum temperature of the respective temperature class.

## 8 Supply Voltage

In addition to the above mentioned temperature characteristics, the PTC elements show a varistor effect. They control their resistance in accordance to the supply voltage. The output may be a maximum of +/- 15% than that shown on the diagram on page 1.

## 9 Wiring Diagram

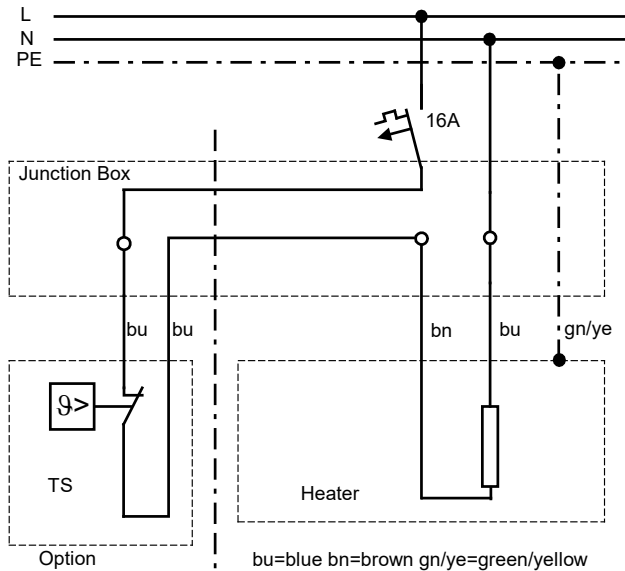

## 10 Dimensions

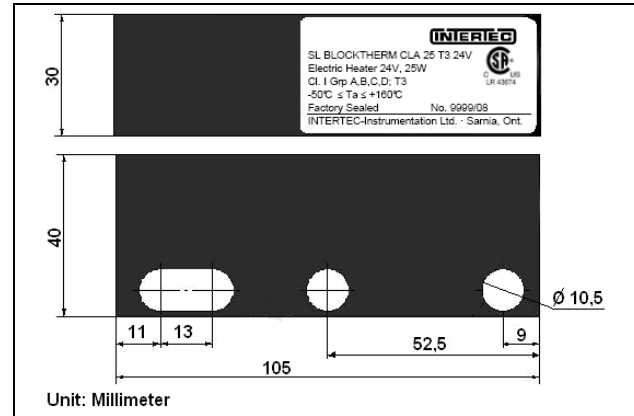

## 11 Mounting

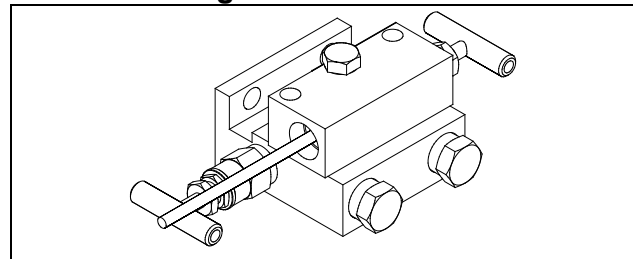

The block heater dissipates the heat by conduction. It should be mounted to a flat surface of a heat conducting material (e.g. metal). One bolt is sufficient to mount the heater.

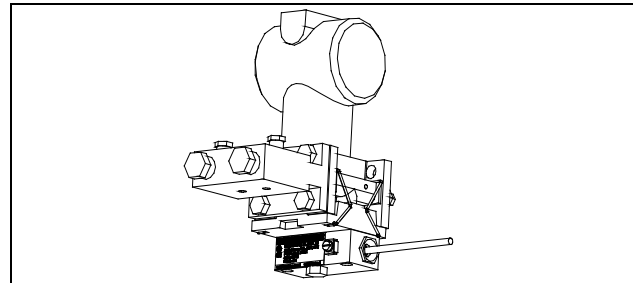

The block heater dissipates the heat by conduction. It should be mounted to a flat surface of a heat conducting material (e. g. metal). One bolt is sufficient to mount the heater.

### Example:

The SL BLOCKTHERM CLA 25 T3 24V which is attached to a Fisher-Rosemount 3051H Transmitter by means of an aluminum adapter block, guarantees freeze protection for the transmitter, manifold and impulse lines installed in an INTERTEC Instrument Enclosure at an outside temperature as low as -15°C.



# Operating Instructions for Heaters SL ...THERM



## 1 Application

SL ...THERM Heaters are manufactured in accordance with Directive 94/ 9EC (ATEX 100a) and are approved as conduction heaters (direct heating via flange-mounting to the instrument) and/or as convection heaters (heat transfer to the ambient air by natural convection) for use in Ex-zones 1 and 2 for explosion groups G/ D in temperature classes T3 to T6.

Optional thermostats can be integrated in the connecting cable.

The respective operating instructions have to be observed.

EC Type Examination Certificate

PTB 02 ATEX 1116X with Schedule and Supplements in German and English as well as IEC Scheme Certificate IECEX PTB 07.0055X please see [www.intertec.info](http://www.intertec.info).

## 2 Technical Data

Rated voltage	24 VDC
Permissible operating voltage	22 - 26 VDC
Rated current (taking into account VDE 0298)	Max. 10 A
Ambient temperature	- 60 to + 60 °C
Max. permissible operating temperature range at normal rating	- 60 to + 180 °C

## 3 Installation

Take care not to bend or exert any load on the connection cable during the transportation or unpacking of the heater.

To ensure effective convection, the heater should be installed in accordance to the installation and minimum clearance requirements described in the data sheets.

Please note that the absolute heat transfer coefficient of the surrounding enclosure must not be smaller than 0.5 W/ K. Also make sure to comply with the permissible operating temperature range.

Before entry in the customer-supplied junction box, the cable must be firmly installed, observing the permissible bending radius of 5 times the outside cable diameter.

In the dust - hazardous area with the applicable requirements of the EN 60079-14 have to be observed.

## 4 Connection

The heater must only be connected and secured by personnel technically qualified in accordance with the label specifications "rated voltage" and "rated current":

If operating voltage = rated voltage, the heater will generate the specified nominal output, with an allowance to voltage fluctuations of up to 10 %.

Circuit breakers suitable for up to 16 A can be used for short circuit and line protection.

A ground terminal is provided for the purpose of ensuring potential equalization. The terminal is marked as such.

In a TT or TN system, a residual current operated protective device (RCD) must be used whose rated response fault current does not exceed 100 mA. Residual current devices with a rated response fault current of 30 mA are to be preferred.

In an IT system, an insulation monitor must be used that switches off the power supply as soon as the insulation resistance falls to 50 ohms per volt of the rated voltage or lower (see DIN EN 60079-14:2008; section 7.4).

## 5 Initial Operation

The heater can be switched on as soon as it is properly installed in accordance with the installation instructions specified in points 3 and 4, ensuring free convection and the necessary clearances.

## 6 Maintenance

Due to the type of construction, the heater requires no maintenance.

Performance and safety tests can be conducted at intervals to be determined by the operator in compliance with current regulations.

Repair work must only be carried out by the manufacturer. In the dust - hazardous area with the applicable requirements of EN 60079-17 and the EN 60079-19 have to be observed.

## 7 Safety instructions

Installation of the heater in an exposed position involves a certain risk of injury, with especially the ends of the fins and hot surfaces posing a potential danger.

- Max. 160°C with T3 Heaters
- Max. 100°C with T4 Heaters
- Max. 70°C with T5 heaters
- Max. 50°C with T6 heaters



Protected operating conditions



www.intertec.info

# SL BLOCKTHERM C Self-limiting Block Heater

## 1 Application

The self-limiting electric conduction heater is designed to be attached directly to manifolds, measuring or analyzing instruments, control valves and similar equipment installed in hazardous areas. It heats the device by conduction. This is the easiest, safest and most economical method of freeze protection or temperature maintenance.

## 2 Features & Advantages

- Energy saving, high output
- Self-limiting, no fusible link or limiter
- Compact, requires very little space
- Adjusts automatically to the voltage

## 3 Description

BLOCKTHERM is a metal heating block with a 1/2" NPT thread to connect to a conduit. The PTC cartridge provides the heat that is transferred through the heater block to the device to which it is attached.

## 4 Performance

A conduction heater requires considerably less power than a finned convection heater, as the heat conduction qualities of metal are much better than those of air. The air surrounding the whole installation in the enclosure serves as additional insulation.

The diagram below shows the heating power at different block temperatures.

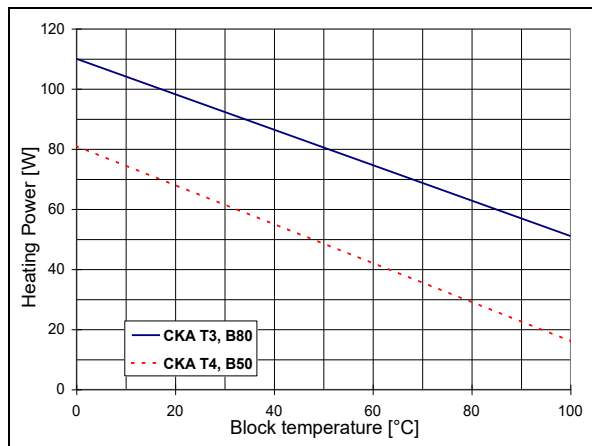

## 5 Explosion Protection

CSA Certificate	1655545 (LR43674)
CSA Type of Protection	Cl. 1, Div. 1, Grp, ABCD Cl. 2, Grp, EFG

## 6 Technical Data

Ingress Protection	IP 68
Nominal voltage	110 to 277 V
Ambient Temperature	-76 F to 302 F / -60° C to +150° C
Connection cable	3x AWG16; Ø 0,37"/ 9,4 mm
Conduit connection	1/2" NPT
Length of Cable	39"/ 1 m
Dimensions	see Types and drawings page 2
Material	seawater-proof aluminium, black anodized

SL BLOCKTHERM				
Profile	CKA T3	CLA T3	CKA T4	CLA T4
Temperature Class	T3		T4	
Nominal Power	80 W		50 W	
Length of Block (see Pt.11)	3.5" / 90 mm	4.1" / 105 mm	3.5" / 90 mm	4.1" / 105 mm
Weight	ca. 1,1lb/ 500g		ca. 1,1 lb/ 500g	

All INTERTEC explosion-proof heaters can also be supplied

- European standard (ATEX)  
e.g.: SL BLOCKTHERM **DKA** T3
- as Bi-Standard (see datasheet HD508)
- in a less expensive, **Non**-explosion-proof design  
e.g.: SL BLOCKTHERM **NKA**

## 7 Options

TSxx JC	Thermostat kit with 3 port junction box
AM	Failure alarm, opens at < 41 F/ 5 °C and can only be ordered on the "L" version body
3M	Connection cable 10' / 3m long

Not all options can be combined.

### Ordering example:

SL BLOCKTHERM CKA T3 **3M**



# SL BLOCKTHERM C Self-limiting Block Heater

## 8 Temperature Limitation

PTC-Elements (Positive Temperature Coefficient) raise their electric resistance with rising temperature. High resistance results in low heating power. The heating power is very low at high temperatures so that the temperature cannot exceed the maximum temperature of the respective temperature class.

## 9 Supply Voltage

In addition to the above mentioned temperature characteristics, the PTC elements show a varistor effect. They control their resistance in accordance to the supply voltage. The nominal power supply voltage may be 110 to 277 V with the same heater. The output may be a maximum of 15% higher than that shown on the diagram on page 1.

## 10 Electric Wiring

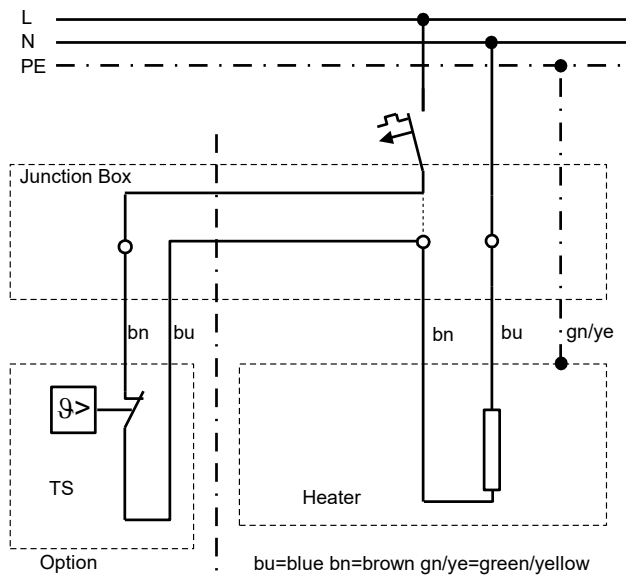

## 11 Dimensions

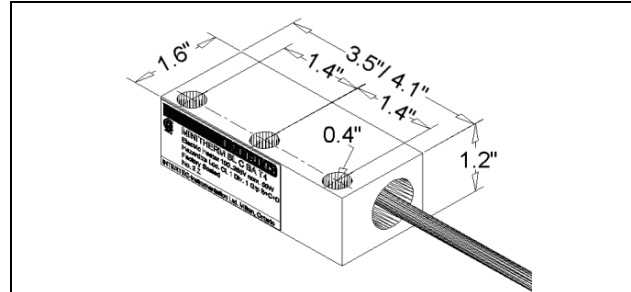

## 12 Mounting

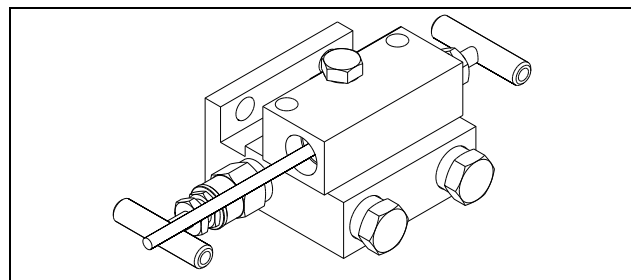

The BLOCKTHERM heater dissipates the heat by conduction. It should be mounted to a flat surface of a heat conducting material (e.g. metal). One bolt is sufficient to mount the heater.

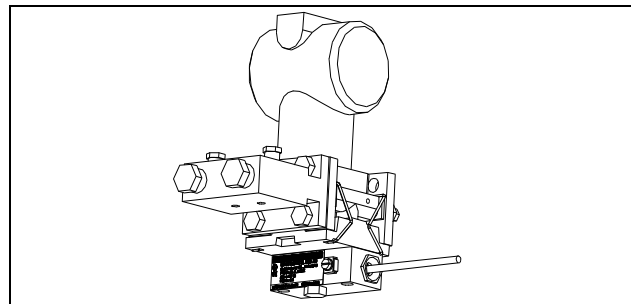

### Example:

The SL BLOCKTHERM CKA T4, which is attached to a Fisher-Rosemount 3051H Transmitter by means of an aluminum adapter block, guarantees freeze protection for the transmitter, manifold and impulse lines installed in an INTERTEC Instrument Enclosure at an outside temperature as low as -13 °F/ -25 °C.

As well the SL BLOCKTHERM CKA T3 will provide protection to -49 °F/ -45 °C.



# Operating Instructions for Heaters SL ...THERM



## 1 Application

SL ...THERM Heaters are manufactured in accordance with Directive 94/ 9EC (ATEX 100a) and are approved as conduction heaters (direct heating via flange-mounting to the instrument) and/or as convection heaters (heat transfer to the ambient air by natural convection) for use in Ex-zones 1 and 2 for explosion groups G/ D in temperature classes T3 to T6.

Optional thermostats can be integrated in the connecting cable.

The respective operating instructions have to be observed.

EC Type Examination Certificate

PTB 02 ATEX 1116X with Schedule and Supplements in German and English as well as IEC Scheme Certificate IECEX PTB 07.0055X please see [www.intertec.info](http://www.intertec.info).

## 2 Technical Data

Rated voltage	110 to 250 V AC or DC
Permissible operating voltage	Max. 265 V AC or DC
Rated current (taking into account VDE 0298)	Max. 10 A
Ambient temperature	- 60 to + 60 °C
Max. permissible operating temperature range at normal rating	- 60 to + 180 °C
Switching capacity of failure alarm	10 A/ 250 V AC

## 3 Installation

Take care not to bend or exert any load on the connection cable during the transportation or unpacking of the heater.

To ensure effective convection, the heater should be installed in accordance to the installation and minimum clearance requirements described in the data sheets.

Please note that the absolute heat transfer coefficient of the surrounding enclosure must not be smaller than 0.5 W/ K. Also make sure to comply with the permissible operating temperature range.

Before entry in the customer-supplied junction box, the cable must be firmly installed, observing the permissible bending radius of 5 times the outside cable diameter.

In the dust - hazardous area with the applicable requirements of the EN 60079-14 have to be observed.

## 4 Connection

The heater must only be connected and secured by personnel technically qualified in accordance with the label specifications "rated voltage" and "rated current":

If operating voltage = rated voltage, the heater will generate the specified nominal output, with an allowance to voltage fluctuations of up to 10 %.

Circuit breakers suitable for up to 16 A can be used for short circuit and line protection.

A ground terminal is provided for the purpose of ensuring potential equalization. The terminal is marked as such.

In a TT or TN system, a residual current operated protective device (RCD) must be used whose rated response fault current does not exceed 100 mA. Residual current devices with a rated response fault current of 30 mA are to be preferred.

In an IT system, an insulation monitor must be used that switches off the power supply as soon as the insulation resistance falls to 50 ohms per volt of the rated voltage or lower (see DIN EN 60079-14:2008; section 7.4).

## 5 Initial Operation

The heater can be switched on as soon as it is properly installed in accordance with the installation instructions specified in points 3 and 4, ensuring free convection and the necessary clearances.

## 6 Maintenance

Due to the type of construction, the heater requires no maintenance.

Performance and safety tests can be conducted at intervals to be determined by the operator in compliance with current regulations.

Repair work must only be carried out by the manufacturer. In the dust - hazardous area with the applicable requirements of EN 60079-17 and the EN 60079-19 have to be observed.

## 7 Safety instructions

Installation of the heater in an exposed position involves a certain risk of injury, with especially the ends of the fins and hot surfaces posing a potential danger.

- Max. 160°C with T3 Heaters
- Max. 100°C with T4 Heaters
- Max. 70°C with T5 heaters
- Max. 50°C with T6 heaters

# BEFORE YOU START





## Safety Warnings

The images below will be used to alert you to various types of safety messages. Obey all safety messages that follow this symbol to avoid possible injury/death or equipment damage.

 **WARNING** messages will appear before procedures that could result in *serious personal injury or death*.

 **CAUTION** messages will appear before procedures that could result in *minor or moderate injury*.

 **NOTICE** messages will appear before procedures that could result in *damage to equipment*.

 **WARNING:** Read this manual completely and carefully before installing or using this product. Failure to do so can result in serious injury or death. Save these instructions for future reference and for the local inspector's use. Observe all governing codes and ordinances.

### General

- Improper selection/installation/maintenance, misuse, or abuse of this equipment can cause death, serious injury, and property damage.
- Performing maintenance often requires referencing the Installation/Operation sections of the full Product Manual. Use the QR code above for quick navigation.
- Do not exceed ANY equipment pressure ratings. Refer to the technical specifications table for maximum pressure rating of the system. Verify the designed pressure ratings of all equipment in your system (supply lines, fittings, connections, filters, valves, gauges, etc.). Prior to use in a system, a properly-sized relief device is to be installed, which limits the use of 110% of the MAWP.
- Some fluids, when burning, do not exhibit a visible flame. Use extreme caution when inspecting and/or servicing systems using flammable fluids to avoid death or serious injury to personnel. Provide a device to warn personnel of these dangerous conditions.
- Not designed for external fire or for use with mixtures of an explosive gas and air/oxygen.
- Do not use the regulator as a shut-off device. A ball valve on the outlet is recommended for this purpose. Our Genie Regulator Accessory Manifold™ is designed to thread directly into any Genie Probe Regulator™ or Genie Regulator and provides a means to monitor regulator outlet pressure and block flow.

### 901-GR Electrical

 **WARNING:** Electrical power must be "OFF" before and during installation and maintenance or personal injury may result.

- 901-GR
- All appropriate national, state, and electrical codes must be followed.
  - Do not remove the temperature controller from the instrument enclosure; the wires may disconnect from the controller terminals.
  - To adjust the set temperature of the heated regulator, remove the instrument enclosure cover and use the arrow keys to adjust the set temperature. This must be done in a non-hazardous location prior to installation. Note: the range of adjustment is 95°F to 300°F.
  - When installed in a hazardous location, the instrument enclosure cover should NOT be removed unless power to the regulator is de-energized prior to maintenance.
  - Do not exceed 5 minutes with power without fluid flow or the thermal cut-off will open the circuit.
  - A sealing fitting must be installed with access, allowing the dams to be made and the sealing compound to be properly poured.
  - All unused conduit openings must be plugged. Plugs must be a minimum of 1/8" thick and engage in a minimum of 5 full threads.

### GHR Electrical

 **WARNING:** Electrical power must be "OFF" before and during installation and maintenance or personal injury may result.

- GHR
- All appropriate national, state, and electrical codes must be followed. In Europe, EN 60079-14 latest applicable edition should be followed.
  - The power supply is with the help of a silicone cable, notch and oil resistant. The cable is intended for installation inside a rigid metal conduit, cable tray or a similar method which provides sufficient mechanical strength to the cable against stress and bending. Ground to be provided at the final location of installation.



Leading the industry in Analytically Correct™ Sampling Systems, Components, and Technology. By applying sound principles of science and a minimalistic design approach, we manufacture our products to solve your specific sampling needs. We specialize in Analytically Correct Sample System Design, Sample Conditioning Components, and revolutionary gas and liquid sampling technology. **We are The Sampling Experts™.** ISO 9001:2015 certified

Genie®, GHR™, are trademarks or registered trademarks of A+Corporation, LLC. All other referenced trademarks are the property of their respective owners. © 2012 A+ Corporation. All rights reserved. SCC-GHR-InsMaintenance\_031423



Contact us for expert product application assistance.

**1.225.644.5255**  
[sales@geniefilters.com](mailto:sales@geniefilters.com)

[geniefilters.com](http://geniefilters.com)

41041 Black Bayou Road  
 Gonzales, Louisiana 70737 United States





## Maintenance Notes

- Periodic inspection of your equipment is required for continued safe operation (at least once per year). Perform visual and mechanical checks on all components on a regular basis. Visually inspect for damaged or worn parts, or leakage evidence by water or corrosion in the interior.
- Although there are no routine maintenance items for the regulator, repair kits are offered for *inlet filter* and *seat & seal* (if the regulator contains non-standard seals, the seal material type will be etched on the body under the A+ logo). Please contact the factory or your local distributor for part numbers and pricing or for the evaluation of any failures or other needed repairs.
- Some applications may require the sample gas to be heated prior to pressure regulation in order to prevent condensation and preserve sample integrity. If your regulator has been repaired and you continue to have performance issues, please contact the factory or your local distributor for an application review to determine if you may need another type of regulator.
- Review the Safety Warnings below before performing any maintenance.

**WARNING:** To avoid personal injury, property damage, or equipment damage caused by a sudden release of pressure or explosion of accumulated gas, do not attempt any maintenance or disassembly without first isolating the regulator from system pressure and relieving all internal pressure from the regulator.

## HEATER BLOCK REPLACEMENT does not apply to 901-GR

### Required Tools and Materials

- 1/8" allen wrench
- 5/16" wrench or nut driver for bracket removal
- Gloves

## 1. Remove heater

**CAUTION:** The regulator may be HOT. Allow ample time for the heater to cool prior to performing maintenance and use gloves to avoid burns.

1. Remove the fasteners (nuts, washers, and spacers) that are holding the heater block in place. **DO NOT** discard the fasteners.
2. Remove the heater from the regulator.



## 2. Install new heater

1. Place the new heater in the bracket with its cord on the same side as the inlet port.
2. Use the original fasteners to attach the heater to the bracket.
3. Refer to powering up steps in the **INSTALLATION** and **OPERATING** section of the **PRODUCT MANUAL FOUND ONLINE** for instructions on establishing flow and setting pressure.

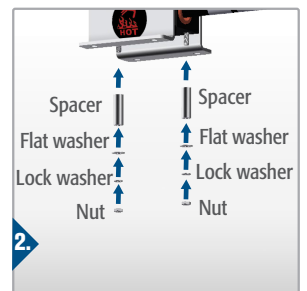
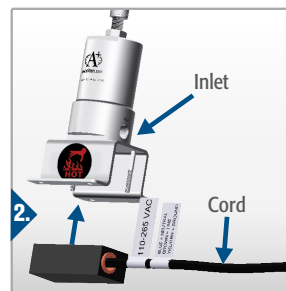

Leading the industry in Analytically Correct™ Sampling Systems, Components, and Technology. By applying sound principles of science and a minimalistic design approach, we manufacture our products to solve your specific sampling needs. We specialize in Analytically Correct Sample System Design, Sample Conditioning Components, and revolutionary gas and liquid sampling technology. **We are The Sampling Experts™.** ISO 9001:2015 certified

Genie®, GHR™, are trademarks or registered trademarks of A+Corporation, LLC. All other referenced trademarks are the property of their respective owners. © 2012 A+ Corporation. All rights reserved. SCC-GHR-InsMaintenance\_031423



Contact us for expert product application assistance.  
**1.225.644.5255**  
[sales@geniefilters.com](mailto:sales@geniefilters.com)  
**geniefilters.com**  
41041 Black Bayou Road  
Gonzales, Louisiana 70737 United States



## INLET FILTER REPLACEMENT

### Required Tools and Materials

- Retaining ring pliers
- Gloves

## 1. Remove old parts

**CAUTION:** The regulator may be HOT. Allow ample time for the heater to cool prior to performing maintenance and use gloves to avoid burns.

1. Use retaining ring pliers to remove and discard the retaining ring from the inlet port.
2. Remove and discard the filter disc and gasket located behind the retaining ring.
3. Remove and clean the heat transfer rod (dowel pin and spring).

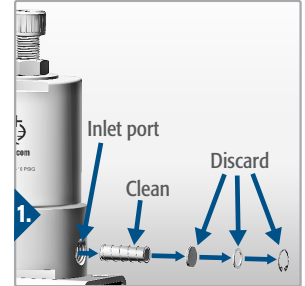

## 2. Install new parts

1. Install the heat transfer rod (dowel and spring), new gasket, and new filter into the inlet port.
2. Use retaining ring pliers to install the retaining ring into the inlet port.
3. Refer to powering up steps in the INSTALLATION and OPERATING section of the PRODUCT MANUAL FOUND ONLINE for instructions on establishing flow and setting pressure.

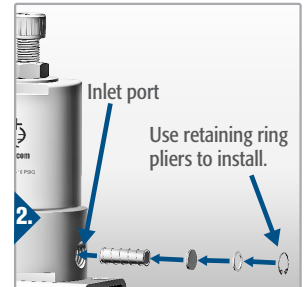

## SEAT & SEAL REPLACEMENT

### Required Tools and Materials

- Spanner bit (included with kit)
- In/lbs torque wrench/screwdriver
- Ft/lb torque wrench
- Krytox<sup>®</sup> GPL 206 lubricant
- Loctite<sup>®</sup> 243 thread adhesive
- 1.5" open end wrench or crow's foot
- Needle-nose pliers
- 1/4" hex drive screwdriver
- Acetone or similar solvent
- Vice
- Gloves

## 1. Remove heater base

**CAUTION:** The regulator may be HOT. Allow ample time for the heater to cool prior to performing maintenance and use gloves to avoid burns.

**GHR**

1. Refer to the Heater Block Replacement section for instructions on removing the heater block from the regulator.

**901-GR**

1. Use a phillips head screwdriver to remove the regulator from the heater base.

(continued)

## 2. Separate the two halves

1. Clamp the regulator in a vice using the wrench flats near the bottom half of the regulator body.
2. Remove the bolt, nut, washer, and o-ring from the top of the regulator. Discard **ONLY** the o-ring.
3. Use a 1.5" open end wrench or crow's foot to loosen the top by rotating it counterclockwise. **DO NOT** unscrew all of the way or the parts in the top will fall out.
4. Remove the regulator from the vice and turn it upside-down.
5. Separate the two halves and place the top upside-down on a clean work space.

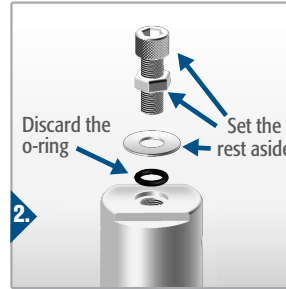

## 3. Replace parts from bottom

1. Remove piston from regulator bottom.
2. Remove the #2-015 o-ring from piston, discard and replace with a new o-ring.
3. Use spanner bit and 1/4" hex drive screwdriver to remove the seat retention nut.
4. Gently grab the end of the stem and pull out with needle-nose pliers.
5. Discard the o-ring, stem, seat and spring. **DO NOT** discard the seat retention nut.

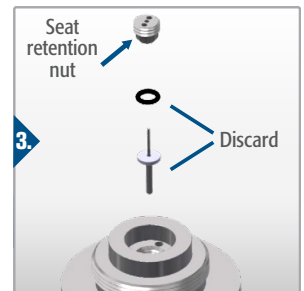
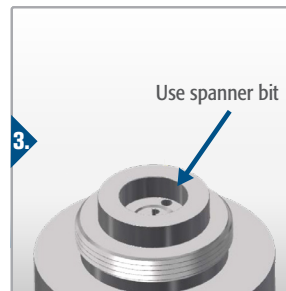
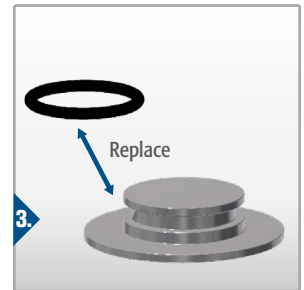
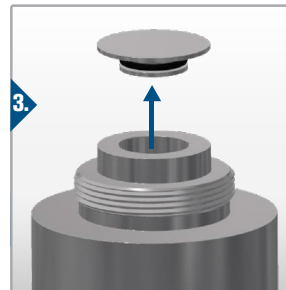

## 4. Replace parts in bottom

1. Place the new spring in the center hole of the regulator bottom.
2. Place a new seat on the small end of the new stem.
3. Locate the spring inside the top center hole of the regulator bottom and place the large end of the stem inside of the spring.
4. Lightly lube the new #2-009 o-ring with Krytox<sup>®</sup> and then set it on top of the seat.
5. Use a small tool to press the o-ring, seat, and stem snugly into the cavity (the white outer casing of a BIC<sup>®</sup> pen works well).
6. Carefully, lightly lube only the threads of the seat retention nut with Krytox<sup>®</sup> and then set it, non-threaded side first, on top of the seat.
7. Use a torque wrench/screwdriver with the spanner bit to torque the seat retention nut to 15 in/lbs.
8. Re-install piston in regulator bottom.

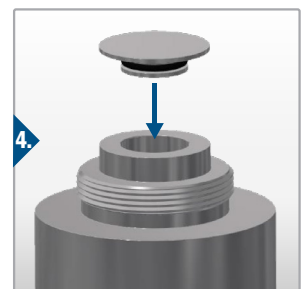
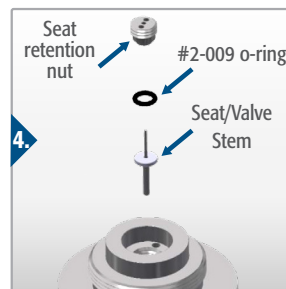
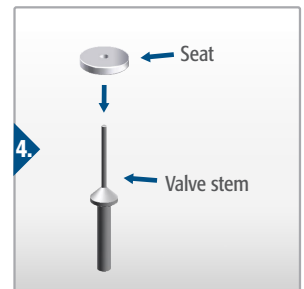
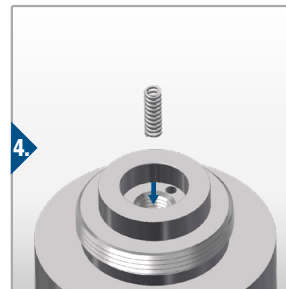

(continued)

## 5. Replace regulator top seal

1. Orient the regulator top so that the larger female threads are facing you.
2. Remove the #2-027 o-ring from the cavity, discard and replace with a new o-ring.
3. If necessary, re-install the load spring and spring button as shown.

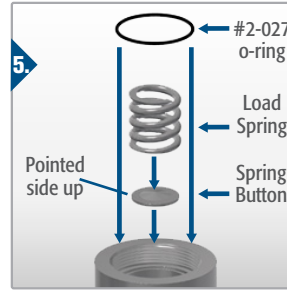

## 6. Tighten the two halves together

1. Carefully apply a thin film of Loctite® 243 thread adhesive to the threads of the regulator bottom.
2. With the regulator top still upside-down, screw the bottom and top together hand-tight.
3. Place the regulator in the vice in its upright position.
4. Use a torque wrench and 1.5" open end wrench/crow's foot to tighten the two halves together to 15 ft/lbs.

## 7. Install parts in top

1. Install the new #2-206 o-ring along with the original bolt, nut, and washer in the top of the regulator.

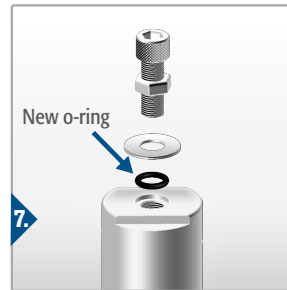

## 8. GHR Install heater block

1. Refer to Heater Block Replacement section for instructions on installing the heater block.

## 901-GR Install regulator on heater base

1. Use a phillips head screwdriver to remove the regulator from on the heater base.

## 9. Reinstall regulator in system

1. Refer to the INSTALLATION AND OPERATION section of the PRODUCT MANUAL FOUND ONLINE for instructions on mounting, powering, establishing flow and setting pressure, etc.

## INLET FILTER REPLACEMENT

### Required Tools and Materials

- Retaining ring pliers
- Gloves

## 1. Remove old parts

**CAUTION:** The regulator may be HOT. Allow ample time for the heater to cool prior to performing maintenance and use gloves to avoid burns.

1. Use retaining ring pliers to remove and discard the retaining ring from the inlet port.
2. Remove and discard the filter disc and gasket located behind the retaining ring.
3. Remove and clean the heat transfer rod (dowel pin and spring).

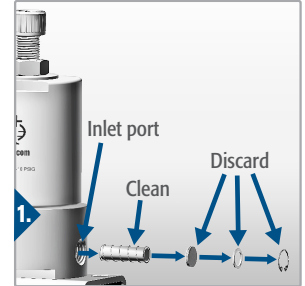

## 2. Install new parts

1. Install the heat transfer rod (dowel and spring), new gasket, and new filter into the inlet port.
2. Use retaining ring pliers to install the retaining ring into the inlet port.
3. Refer to powering up steps in the INSTALLATION and OPERATING section of the PRODUCT MANUAL FOUND ONLINE for instructions on establishing flow and setting pressure.

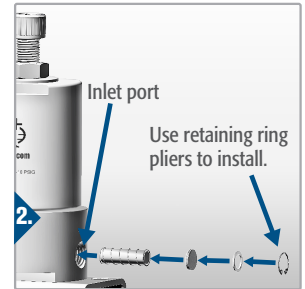

## SEAT & SEAL REPLACEMENT

### Required Tools and Materials

- Spanner bit (included with kit)
- In/lbs torque wrench/screwdriver
- Ft/lb torque wrench
- Krytox<sup>®</sup> GPL 206 lubricant
- Loctite<sup>®</sup> 243 thread adhesive
- 1.5" open end wrench or crow's foot
- Needle-nose pliers
- 1/4" hex drive screwdriver
- Acetone or similar solvent
- Vice
- Gloves

## 1. Remove heater base

**CAUTION:** The regulator may be HOT. Allow ample time for the heater to cool prior to performing maintenance and use gloves to avoid burns.

**GHR**

1. Refer to the Heater Block Replacement section for instructions on removing the heater block from the regulator.

**901-GR**

1. Use a phillips head screwdriver to remove the regulator from the heater base.

(continued)

# PISTON O-RING REPLACEMENT

## Required Tools and Materials

- Gloves

### 1. Separate the two halves

1. Clamp the regulator in a vice using the wrench flats near the bottom half of the regulator body.
2. Remove the bolt, nut, washer, and o-ring from the top of the regulator.
3. Use a 1.5" open end wrench or crow's foot to loosen the top by rotating it counterclockwise. **DO NOT** unscrew all of the way or the parts in the top will fall out.
4. Remove the regulator from the vice and turn it upside-down.
5. Separate the two halves and place the top upside-down on a clean work space.

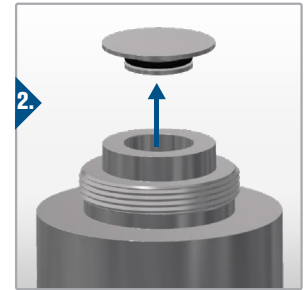
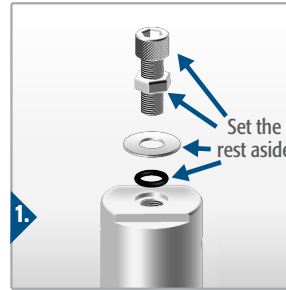

### 2. Replace piston o-ring

1. Remove piston from regulator bottom.
2. Remove the #2-015 o-ring from piston, discard and replace with a new o-ring.
3. Re-install piston in regulator bottom.

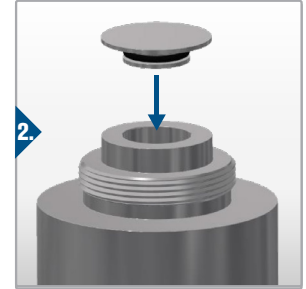
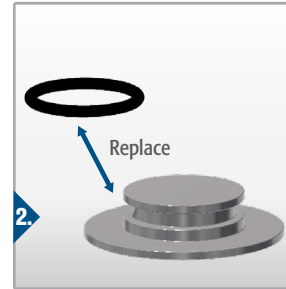

### 3. Tighten the two halves together

**! NOTICE:** If necessary, re-install the load spring and spring button as shown.

1. Carefully apply a thin film of Loctite<sup>®</sup> 243 thread adhesive to the threads of the regulator bottom.
2. With the regulator top still upside-down, screw the bottom and top together hand-tight.
3. Place the regulator in the vice in its upright position.
4. Use a torque wrench and 1.5" open end wrench/crow's foot to tighten the two halves together to 15 ft/lbs.

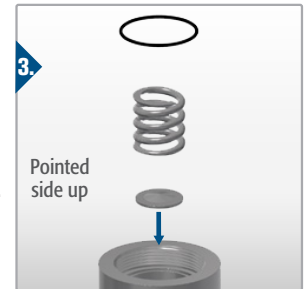

### 4. Install parts in top

1. Install the original bolt, nut, washer, and o-ring into the top of the regulator.

### 5. Install heater block

1. Refer to Heater Block Replacement section for instructions on installing the heater block.

### Install regulator on heater base

1. Use a phillips head screwdriver to attach the regulator from on the heater base.



### 6. Reinstall regulator in system

1. Refer to the INSTALLATION AND OPERATION section of the PRODUCT MANUAL FOUND ONLINE for instructions on mounting, powering, establishing flow and setting pressure, etc.

901-GR GHR