

+ Housing (Model H) Installation & Operation Instructions

Tools & Materials

- Flashlight
- Adjustable Wrench
- 3/16 Allen Wrench
- Accessory Manifold (available for purchase)

Safety Warnings

- ⚠** Failure to abide by any of the safety warnings or operation of this device outside the limits stated below may result in equipment failure and serious injury or death.
- This product may vent while being installed, operated, or maintained. The user should follow company safety practices concerning Personal Protective Equipment (PPE) as well as any and all OSHA, state and local regulations.

Additional Information

N/A

Model Identification

- OVERVIEW

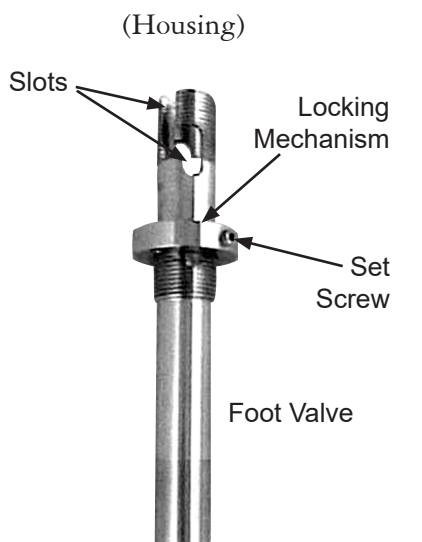

An ISO 9001:2015 certified company

Installation & Operation Instructions

Overview Instructions & Explanations

- HOUSING - GPR, GP2

1- Locking Mechanism

- 1.1 To ensure that the housing is never accidentally loosened or removed a locking mechanism is provided. Our locking mechanism ensures that the housing can only be removed intentionally or knowingly. (Set screws backed out, top view **Figure 1**. Set screws fully engaged, bottom view **Figure 2**.)
- 1.2 With set screws backed out, turn locking mechanism on the housing (counter-clockwise) until it is at its extreme upper position.
- 1.3 Apply thread sealant to thread area below vertical slot in threads. 4 wraps of Mil Spec A-A 58092 nickel Teflon Tape thread sealant is recommend. (**Figure 3**)

NOTE: Do not allow thread sealant to invade slot, otherwise it may interfere with locking mechanism.

2- Mounting Orientation

- 2.1 A vertical mounting orientation is preferred. At most, a 45° maximum angle is acceptable.

3- Insertion of Housing

- 3.1 Confirm that the pipeline has been depressurized.
- 3.2 Insert the housing into the depressurized pipeline through a ¾" NPT thread-o-let. (An optional 1" NPT housing is available.)

NOTE: When using a reducing bushing to install a ¾" GP Series Probe Housing in a 1" NPT thread-o-let, **FIRST** connect & tighten the bushing onto the probe **BEFORE** connecting the bushing to the thread-o-let.

(continued)

Figure 1

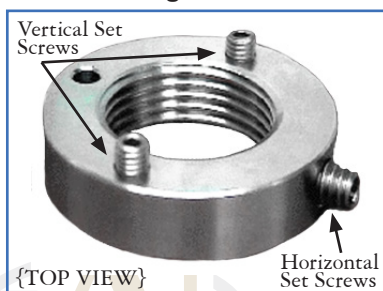

Figure 2

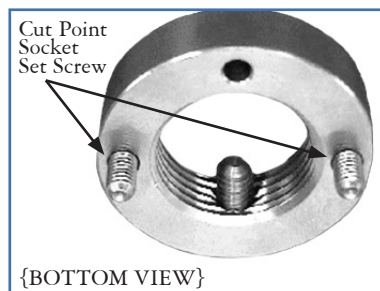
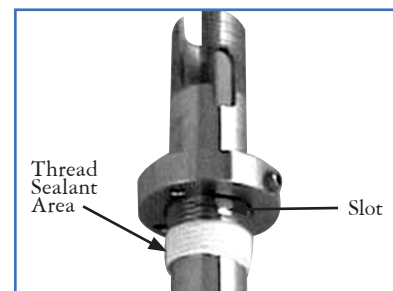

Figure 3



Installation & Operation Instructions

Overview Instructions & Explanations

- HOUSING - GPR, GP2

4- Secure Housing

- 4.1 Using a wrench and the wrench flats, turn the housing until it is secure and sealed. Typically 3-5 turns is sufficient. (Figure 4)

⚠ NOTE: DO NOT OVERTIGHTEN. The housing may be damaged if over tightening causes the housing to swage.

- 4.2 To position the housing or to seal, a maximum of one additional turn can be used.

5- Thread Locking Mechanism

- 5.1 Turn the locking mechanism clockwise until it first touches the top of the thread-o-let. (Figure 5)

6- Allen Screw Tighten

- 6.1 Turn the locking mechanism counterclockwise until the allen screw is aligned with the thread slot.
6.2 Using a 1/8" allen wrench, tighten the allen screw until its tip is tight against the slot. (Figure 6)
6.3 Do not over tighten allen screw, otherwise housing wall may become indented.

7- Set Screw Lock

- 7.1 Using a 3/32" allen wrench, tighten the allen screws on the locking mechanism's surface until their tips are firmly set into the thread-o-let's upper surface. (Figure 7)

Figure 4

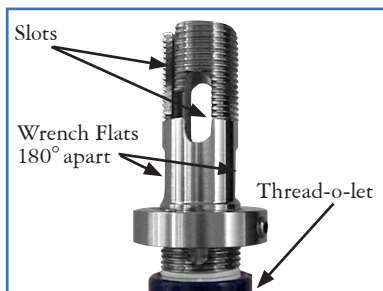

Figure 5

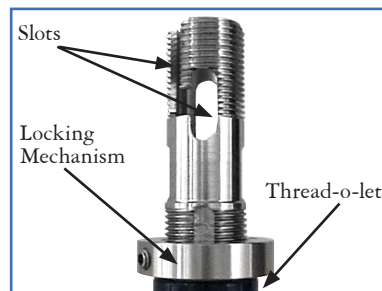

Figure 6

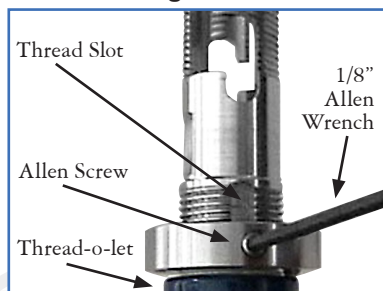
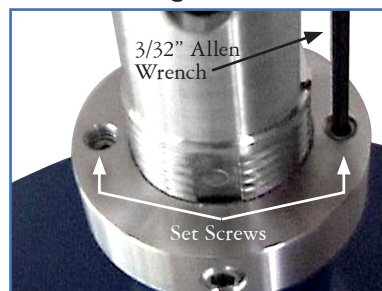

Figure 7



(continued)

Installation & Operation Instructions

Overview Instructions & Explanations

- HOUSING - GPR, GP2

8- Housing Installed

- 8.1 The housing is now installed. The locking mechanism should prevent the housing from becoming unintentionally unscrewed from the thread-o-let. (Figure 8)
- 8.2 The pipeline may now be re-pressurized.
- 8.3 Once the housing is installed, install the weather head (Figure 9) or stainless steel plug (Figure 10) that prevents foreign objects from entering the housing cavity if a probe is not to be installed at this time. Ignore this step if you are continuing on to probe insertion.

Figure 8

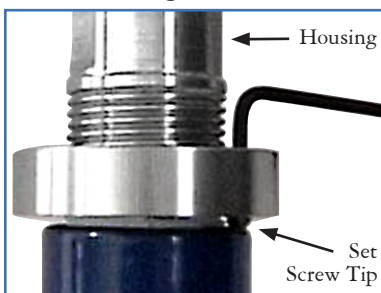

Figure 9

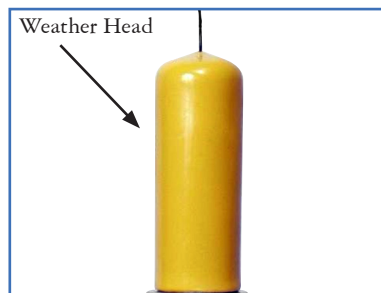
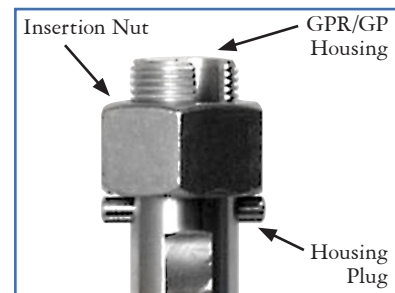

Figure 10



Installation & Operation Instructions

Overview Instructions & Explanations

- INSERTION - GPR, GP2

NOTE: Protection begins with the robust foot valve design. A stainless steel spring provides the initial upward force to close the foot valve. The process pressure provides additional force after the foot valve is closed. (Figure 1 & 2)

NOTE: The GP2 & GPR housing has two vertical zig-zag slots known as J-Slots. (Figure 3)

1- Inspect Housing Cavity

1.1 If a weather head or stainless steel plug is present, remove and confirm that no foreign objects are in the housing cavity. Use a light source (flashlight) to view the top of the foot valve housing and stem. (Figure 3)

2- Check Allen Cap Screw

2.1 Confirm that the allen cap screw head's hollow hex cavity is free from foreign material. (Figure 4)

2.2 Confirm that the allen cap screw that holds the membrane ferrule is torqued wrench-tight. The torque value should be 10 inch/lb. If the allen cap screw is only hand tight, not wrench tight to the appropriate torque value, the screw may protrude excessively. (Figure 5) The extra probe length may prematurely actuate the foot valve when the probe is installed into the housing.

Figure 1

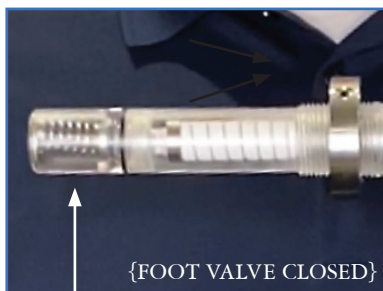

Figure 2



Figure 3

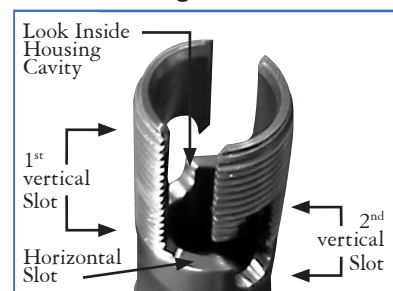
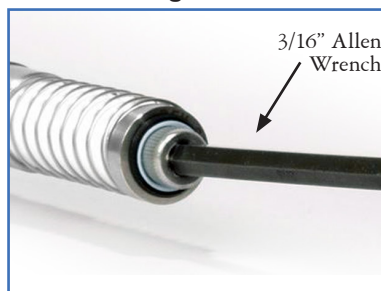

Figure 4



Figure 5



(continued)

Installation & Operation Instructions

Overview Instructions & Explanations

- INSERTION - GPR, GP2

3- GPR ONLY (Figure 6)

- Rotate the pressure adjustment screw fully counter- clockwise (unscrew it) until it rotates freely. (Figures 6)
- Close the ball valve on the regulator outlet if so equipped. (Handle at 90° angle.)

3.1 GP2 ONLY

- If not ordered with a hex adapter, first install a valve in the GP2 outlet port (1/8" FNPT).
- Close the valve before inserting the GP2 into its housing.

NOTE: Failure to install and close the valve will result in full line pressure at the outlet port, and the unrestricted flow could damage the foot valve o-ring.

- Use a backup wrench on the wrench flats during valve installation.

3.2 COMPOSITE SAMPLER ONLY (Figure 7)

- Install the composite sampler with its inlet valve closed onto the probe. The valve must be closed before inserting the probe into its housing.

NOTE: Failure to install and close the valve will result in full line pressure at the outlet port, and the unrestricted flow could damage the foot valve o-ring.

- Use a backup wrench on the wrench flats during valve installation.

Figure 6

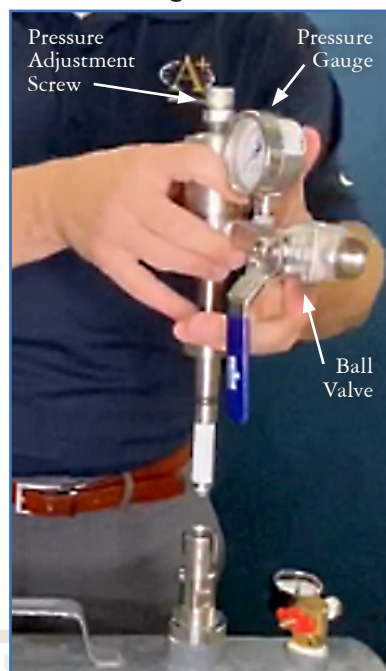
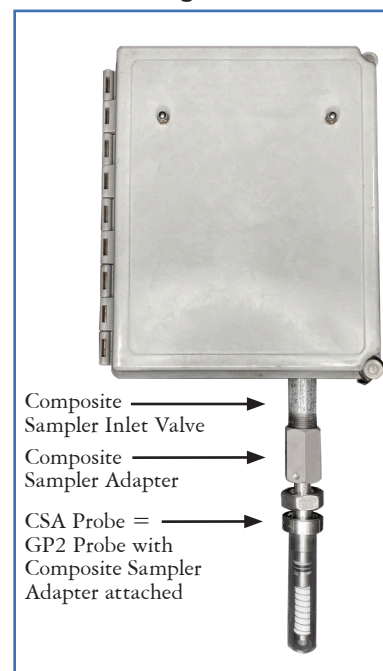

Figure 7



(continued)

Installation & Operation Instructions

Overview Instructions & Explanations

- INSERTION - GPR, GP2

4- Lower Probe Into Housing

- 4.1 Position the membrane end of probe above the installed housing. (Figures 8)
- 4.2 Slowly and carefully, lower the probe into the housing. (Avoid membrane contact with upper section of housing.)
- 4.3 Do not apply any downward force. The probe should easily slide into the housing.
- 4.4 Only lower the probe far enough to thread the insertion nut one complete thread. (Figures 9)
- 4.5 Do not apply any downward force by hand to the Probe.
- 4.6 Do not unscrew the insertion nut in this procedure once it has been engaged. (The pins are in the 1st vertical slot.)

5- Thread Insertion Nut

- 5.1 Thread the insertion nut down by hand, lowering the probe until the insertion washer pins slide to the bottom of the first vertical slot. (Figures 10)
- 5.2 The threaded nut on the housing ensures that if all other safety procedures are disregarded, it is mechanically impossible to remove the probe. (The pins are at the bottom of the 1st vertical slot.)

6- Rotate Probe

- 6.1 Rotate probe counter clockwise until the pins are to the far right in the horizontal slot. At this point the probe is sealed against the housing interior wall. (The pins are in the middle of the 2nd vertical slot.) (Figures 11)

Figure 8

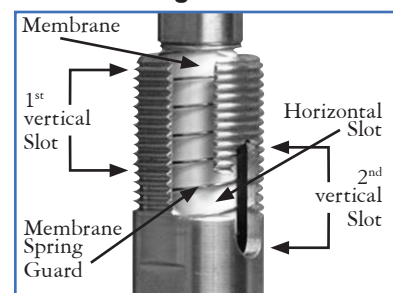

Figure 9

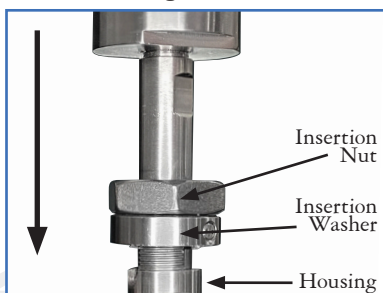

Figure 10

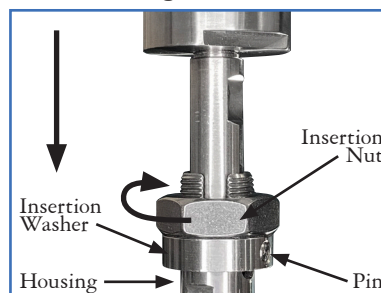
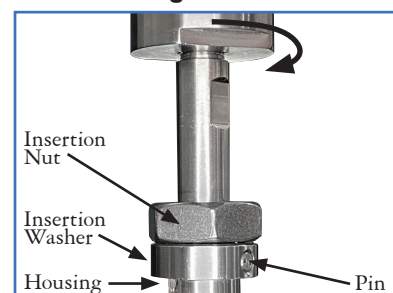

Figure 11



(continued)

Installation & Operation Instructions

Overview Instructions & Explanations

- INSERTION - GPR, GP2

7- Loosen Insertion Nut (Figure 12)

- 7.1 Loosen the insertion nut until it is above the top of 2nd vertical slot. The probe should not rise to the top of the 2nd Vertical Slot. If the probe rises in the 2nd vertical slot, the foot valve o-ring may have been damaged or attacked by the process.
- 7.2 The threaded nut on the housing ensures that it is mechanically impossible to remove the probe. Perform the next step regardless of the status of the foot valve o-ring. (The pins are in the middle of the 2nd vertical slot.)

8- Tighten Insertion Nut (Figure 13)

- 8.1 Tighten the insertion nut (by hand) until it is against the insertion washer again.
- 8.2 Using a wrench, tighten the insertion nut against the insertion washer so that the pins are at the bottom of the 2nd vertical slot.
- 8.3 At this point the foot valve opens and the insertion process is complete. Perform this step regardless of the status of the foot valve o-ring. (The pins are at the bottom of the 2nd vertical slot.)

NOTE: If ordering a threaded atmospheric reference port for the regulator so that optional tubing can be connected to this port to enable a “captured vent”, do NOT plug as the performance of the regulator will be affected.

9- Set Sample Pressure (GPR only)

- 9.1 The sample pressure can be adjusted to the desired value. This is accomplished by turning the pressure adjustment screw clockwise. To allow sample flow, slowly open external valving. (Figure 14)

10- Check & Re-adjust Sample Pressure (Figure 15)

- 10.1 At high supply pressure, a sudden change may be observed on the downstream pressure gauge as the valve stem moves away from the seat. Slight re-adjustments may be necessary until the pressure and flow have equilibrated.
- 10.2 Tighten the pressure adjustment screw lock nut firmly against the washer to prevent unintended changes in pressure adjustment.

Figure 12

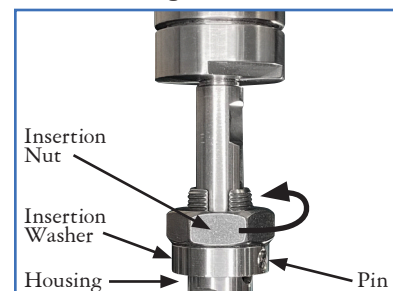

Figure 13

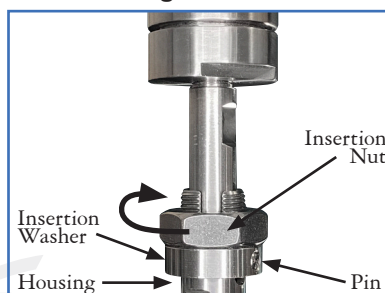

Figure 14

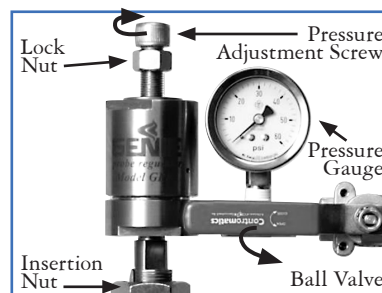
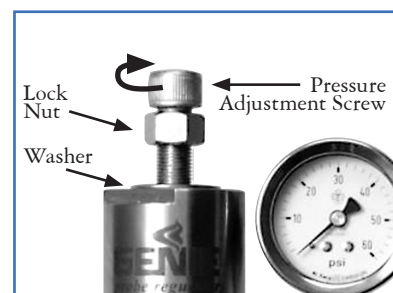

Figure 15



Installation & Operation Instructions

Overview Instructions & Explanations

- RETRACTION - GPR, GP2

1- Retraction Prep

- 1.1 Shut flow completely off by closing external valving before beginning to retract the GPR or GP2 probe.

⚠ NOTE: Failure to shut off sample flow may result in damage to housing foot valve seal.

- 1.2 Confirm that the adjustment screw is completely counter clockwise on GPR or the valve connected to the outlet port on GP2 probes is closed.
- 1.3 (The pins are at the bottom of the 2nd vertical slot. **Figure 1**) Using a wrench, loosen nut until the nut just clears the insertion washer. Do not unscrew the nut beyond the top of the 2nd vertical slot. (**Figure 2**)

2- Second Vertical Slot Position

- 2.1 The pins will now be at the top of the second vertical slot. They are held there by the force of supply gas trapped between the foot valve and probe housing seals.

3- Relieve Pressure

- 3.1 Bleed down the sample pressure by allowing sample to flow externally.
- 3.2 The probe should fall until the pins align with the horizontal slot indicating that the foot valve is closed and the o-ring is sealed properly.
- 3.3 Once you have utilized the safety feature of the 2nd vertical slot to confirm the status of the foot valve o-ring, only then can you remove the probe. (**Figure 3**)
- 3.4 The thread engagement of the insertion nut and the safety feature of the 2nd vertical slot ensure that the probe can not exit the housing any other way than the correct retraction method. (The pins are in the middle of the 2nd vertical slot.)

(continued)

Figure 1

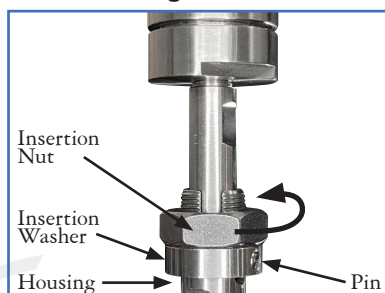

Figure 2

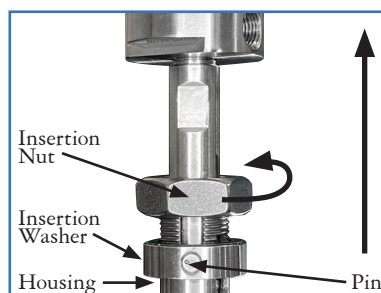
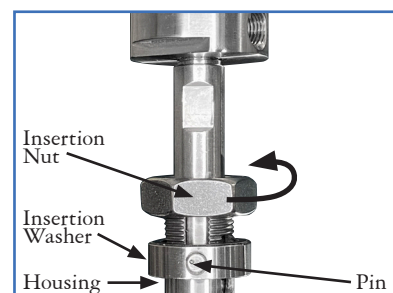

Figure 3



Installation & Operation Instructions

Overview Instructions & Explanations

- RETRACTION - GPR, GP2

4- Confirm Foot Valve Closure

- 4.1 The sample pressure is relieved by allowing sample to flow externally. The probe can now be easily pushed downward until the pins align with the horizontal slots, confirming the foot valve closed correctly.
- 4.2 Even if foot valve failure would possibly occur, the foot valve leak rate would prevent you from pushing the probe downward until the pins align with the horizontal slots. (Figure 4)

NOTE: If the pressure is not reduced to zero, use the wrench to tighten the nut pushing the probe back into the housing and contact A+ Corporation or its representative.

5- Rotate Probe

- 5.1 Rotate the probe clockwise until the pins enter first vertical slots. (Figure 5)
- 5.2 Make sure the insertion nut stays threaded on the housing. (The pins are at the bottom of the 1st vertical slot.)

6- Unthread Nut

- 6.1 Confirm that no upward force from the supply pressure is present. (I.e. the insertion washer is not forced against the insertion nut as it is unthreaded.)
- 6.2 After confirmation that no upward force from the supply pressure is present, completely unthread the insertion nut and lift the probe upward from the housing. (The pins are in the middle of the 1st vertical slot.) (Figure 6)

7- Probe Position

- 7.1 During the retraction, keep the probe centered in the housing to avoid membrane damage by contact with the upper section of the housing. Once the probe clears the housing it may be placed on its side on a flat surface.

Figure 4

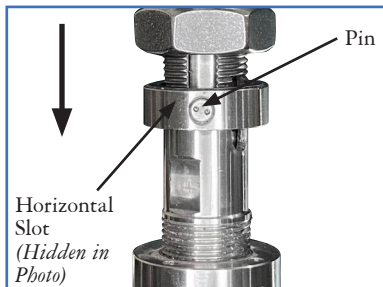

Figure 5

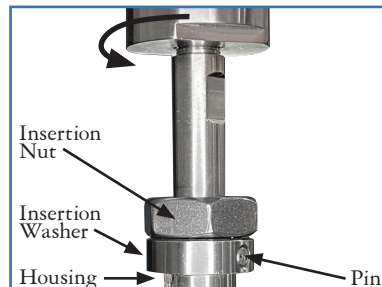

Figure 6

